

GR-5

Featuring Vanguard Technology™



 **TOPCON**



GR-5

Featuring Vanguard Technology

Operator's Manual

Part Number 7010-1004

Rev D

©Copyright Topcon Positioning Systems, Inc.

March, 2016

All contents in this manual are copyrighted by Topcon Positioning Systems, Inc. All rights reserved.

••••• Table of Contents

Preface	ix
Terms and Conditions	ix
Use	ix
Copyrights	x
Trademarks	x
Disclaimer of Warranty	x
License Agreement	xi
Confidentiality	xi
Website; Other Statements	xii
Safety	xii
Miscellaneous	xii
Manual Conventions	xiii
Introduction	1

GR-5 Features	2
Unpacking Your Receiver Kit	3
Standard Kit Components1	3
Accessories	4
Technical Documents	5
Using Topcon Software With Your Receiver	5
Getting Technical Support	6
Website	7
Getting Acquainted	8
Receiver Overview	8
Cables	9
Accessories	11
Batteries	13
Data and Power Ports	14
External Radio Antenna Connector	15
Bottom Connector	16
SD/SDHC and SIM Card Slots	17

SIM Card Slot	18
SIM Cards	18
Installing the SIM Card	18
Display Panel Operations	19
Power Button	20
Receiver Status LEDs	20
STAT LED	21
REC LED	21
RX TX LED	22
Bluetooth LED	24
Battery LED	24
FUNCTION Button/Logging Data	26
Managing Power	30
Turning On/Off the Receiver	30
Powering the Receiver	30
Detachable External Batteries	31
Charging the Batteries	31

Battery Charging Temperatures	34
Charging Procedure	34
Leaving the Batteries on Charge	36
Attaching the Batteries	36
Detaching the Batteries	37
Assembling the AA Battery Shell	37
Surveying While Charging	38
Changing the Batteries while Surveying	39
Using an Auxiliary Power Source	39
Insufficient Power	42
Configuring the Receiver	43
Viewing Receiver Information	43
Loading New Firmware	45
About the OAF	49
Checking the Receiver's OAF	49
Loading an OAF	50
Performing a Factory Reset	53
Field System Setup	55

Setting Up the Base Receiver	55
Setting Up the Rover Receiver	56
Measuring Antenna Height	57
Collecting Data	59
Memory	59
SD/SDHC Card	60
Installing the SD/SDHC Card	60
Initializing the File System	61
Initializing the File System Using TRU	61
Setting Recording Parameters	62
Logging Rates	62
Recording Data	62
Managing Files	64
Downloading and Deleting Files	64
Troubleshooting	65
Check This First!	65
Powering Problems	66

Receiver Problems	67
Bluetooth Problems	71
TRU Problems	73
Cleaning and Storing the Receiver.	74
Getting Customer Support	74
Specifications	75
General Details	75
DUHF II Internal Modem Board Details (Optional).	87
FH915 Internal Modem Board Details	88
Optional Cell Module Details	90
Bluetooth Module Details	93
Connector Specifications	93
Radio (Modem) RF Connector	94
Power Connector	95
Serial C-RS232 Connector	96
USB Connector	98
Brazil-Only Radio Specifications.	99

- Product Identification 102**
- SD/SDHC Card Recommendations 103**
- Safety Warnings 104**
 - General Warnings 104
 - Battery Warnings 105
 - Receiver Warnings 106
 - Usage Warnings 106
- Regulatory 107**
 - FCC Compliance. 107
 - Industry Canada Compliance 108
 - IC RF Radiation Exposure Statement 109
 - IC Additional Statement with Detachable Antennas 109
 - Community of Europe Compliance 111
 - European Community Declaration of Conformity with R&TTE Directive 1999/5/EC 111
 - Declaration of Conformity (R&TTE Directive 1999/5/EC) 114
 - Brazil Anatel Compliance 117
 - WEEE Directive 118

Bluetooth Transmission Statements/Compliance	118
Warranty	119
Glossary	120

Preface



Thank you for purchasing this Topcon product. The materials available in this Manual (the “Manual”) have been prepared by Topcon Positioning Systems, Inc. (“TPS”) for owners of Topcon products, and are designed to assist owners with the use of the receiver and its use is subject to these terms and conditions (the “Terms and Conditions”).



Please read the terms and conditions carefully.

Terms and Conditions

Use

This product is designed to be used by a professional. The user should have a good knowledge of the safe use of the product and implement the types of safety procedures recommended by the local government protection agency for both private use and commercial job sites.

Copyrights

All information contained in this Manual is the intellectual property of, and copyrighted material of TPS. All rights are reserved. Do not use, access, copy, store, display, create derivative works of, sell, modify, publish, distribute, or allow any third party access to, any graphics, content, information or data in this Manual without TPS' express written consent and may only use such information for the care and operation of the receiver. The information and data in this Manual are a valuable asset of TPS and are developed by the expenditure of considerable work, time and money, and are the result of original selection, coordination and arrangement by TPS.

Trademarks

GR-5, Vanguard Technology™, Fence Antenna™ Technology, TRU™, Magnet™, Pocket-3D™, Topcon® and Topcon Positioning Systems™ are trademarks or registered trademarks of TPS. Windows® is a registered trademark of Microsoft Corporation. The Bluetooth® word mark and logos are owned by Bluetooth SIG, Inc. and any use of such marks by Topcon Positioning Systems, Inc. is used under license. Other product and company names mentioned herein may be trademarks of their respective owners.

Disclaimer of Warranty

EXCEPT FOR ANY WARRANTIES IN AN APPENDIX OR A WARRANTY CARD ACCOMPANYING THE PRODUCT, THIS MANUAL AND THE RECEIVER ARE PROVIDED "AS-IS." THERE ARE NO OTHER WARRANTIES. TPS DISCLAIMS ANY IMPLIED WARRANTY OF MERCHANTABILITY OR FITNESS FOR ANY PARTICULAR USE OR PURPOSE. TPS AND ITS DISTRIBUTORS SHALL NOT BE LIABLE FOR TECHNICAL OR EDITORIAL ERRORS OR OMISSIONS CONTAINED HEREIN; NOR FOR INCIDENTAL OR CONSEQUENTIAL DAMAGES RESULTING FROM THE FURNISHING, PERFORMANCE OR USE OF THIS MATERIAL OR THE RECEIVER. SUCH DISCLAIMED DAMAGES INCLUDE BUT ARE NOT LIMITED TO LOSS OF TIME, LOSS OR DESTRUCTION OF DATA, LOSS OF PROFIT, SAVINGS OR REVENUE, OR LOSS OF THE PRODUCT'S USE. IN ADDITION TPS IS NOT RESPONSIBLE OR LIABLE FOR DAMAGES OR COSTS

INCURRED IN CONNECTION WITH OBTAINING SUBSTITUTE PRODUCTS OR SOFTWARE, CLAIMS BY OTHERS, INCONVENIENCE, OR ANY OTHER COSTS. IN ANY EVENT, TPS SHALL HAVE NO LIABILITY FOR DAMAGES OR OTHERWISE TO YOU OR ANY OTHER PERSON OR ENTITY IN EXCESS OF THE PURCHASE PRICE FOR THE RECEIVER.

License Agreement

Use of any computer programs or software supplied by TPS or downloaded from a TPS website (the “Software”) in connection with the receiver constitutes acceptance of these Terms and Conditions in this Manual and an agreement to abide by these Terms and Conditions. The user is granted a personal, non-exclusive, non-transferable license to use such Software under the terms stated herein and in any case only with a single receiver or single computer. You may not assign or transfer the Software or this license without the express written consent of TPS. This license is effective until terminated. You may terminate the license at any time by destroying the Software and Manual. TPS may terminate the license if you fail to comply with any of the Terms or Conditions. You agree to destroy the Software and manual upon termination of the use of the receiver. All ownership, copyright and other intellectual property rights in and to the Software belong to TPS. If these license terms are not acceptable, return any unused software and manual.

Confidentiality

This Manual, its contents and the Software (collectively, the “Confidential Information”) are the confidential and proprietary information of TPS. You agree to treat TPS’ Confidential Information with a degree of care no less stringent than the degree of care you would use in safeguarding your own most valuable trade secrets. Nothing in this paragraph shall restrict you from disclosing Confidential Information to your employees as may be necessary or appropriate to operate or care for the receiver. Such employees must also keep the Confidentiality Information confidential. In the event you become legally compelled to disclose any of the Confidential Information, you shall give TPS immediate notice so that it may seek a protective order or other appropriate remedy.

Website; Other Statements

No statement contained at the TPS website (or any other website) or in any other advertisements or TPS literature or made by an employee or independent contractor of TPS modifies these Terms and Conditions (including the Software license, warranty and limitation of liability).

Safety

Improper use of the receiver can lead to injury to persons or property and/or malfunction of the product. The receiver should only be repaired by authorized TPS warranty service centers.

Miscellaneous

The above Terms and Conditions may be amended, modified, superseded, or canceled, at any time by TPS. The above Terms and Conditions will be governed by, and construed in accordance with, the laws of the State of California, without reference to conflict of laws.

Manual Conventions

This manual uses the following conventions:

Convention	Description	Example
Bold	Menu, or drop-down menu selection Name of a dialog box or screen Button or key commands	File ▶ Exit (Click the File menu and click Exit) From the Connection screen... Click Finish .
Mono	User supplied text or variable	Type <code>guest</code> , and click Enter .
<i>Italic</i>	Reference to another manual or help document	Refer to the <i>Topcon Reference Manual</i> .



Further information to note about system configuration, maintenance, or setup.



Supplementary information that can have an adverse affect on system operation, system performance, data integrity, measurements, or personal safety.



Notification that an action has the potential to result in system damage, loss of data, loss of warranty, or personal injury.

Introduction



Topcon's GR-5 receiver is a compact and high-performing GNSS receiver for static and kinematic applications. The receiver design includes a GNSS receiver board based on Vanguard Technology™, which provides unlimited tracking ability. The GR-5 delivers world-class positioning and navigation capability to your application by tracking signals with multiple frequencies and multi-constellation satellite systems.

Using full-wave Fence Antenna™ Technology, the GR-5 can receive and process multiple signal types, including the latest GPS L2C and L5, and other future¹ signals. The GR-5 receiver includes an enhanced GNSS receiver board featuring Vanguard Technology that supports 226 channels².

GNSS tracking capabilities, dual-frequency RTK, SBAS functionality, extensive communication capabilities, removable memory for files combine to provide a positioning system efficient, secure, and appropriate for any survey.

Several unique features, including advanced multipath mitigation, adjustable Phase-Locked Loop (LLP) and Delay-Locked Loop (DLL), offer a reliable and versatile reception of weak signals even in degraded signal environments. The receiver also supports Quartz Locked Look™ (QLL) for superior GNSS tracking in high-vibration environments.

The GR-5 offers complete IP66 protection against dust and water ingress, in addition to superior vibration and shock resistance. The Topcon communication interface allows you to quickly integrate Topcon's premium GNSS performance within new systems and quickly deliver world-class positioning and navigation support to your applications.

-
1. The GR-5 receiver, equipped with a GNSS board featuring Vanguard technology, is a Galileo- and BeiDou-ready system. Full support of these new constellation(s) and associated signals will be incorporated into the receiver when these constellations are mature and ready for commercial use.
 2. Earlier versions of the GR-5 were built with PII ASIC-based GNSS boards and supported 216 universal tracking channels. See "Product Identification" on page 102 for a list of new GR-5 receivers built with Vanguard technology-based GNSS receiver boards.

GR-5 Features

The GR-5 receiver's advanced design allows for a simplified setup and premium performance. The GR-5 receiver features the following:

- A premier multi-constellation Vanguard technology GNSS board
- Industry leading full-wave Fence Antenna technology
- Detachable batteries for extended operation
- Internal radio and cellular (optional) modems
- Integrated Bluetooth® wireless and radio technology
- Optional HSPA (3.5G)¹ and CDMA cellular technology
- Interface for controlling viewing data logging through the LED display
- External power, USB, and serial-data ports
- External high-capacity memory card support

The GR-5 comes in one of the following configurations:

- FH915+ radio modem
- FH915+ radio modem with HSPA module
- Digital UHF II radio modem
- Digital UHF II radio modem with HSPA module
- Digital UHF II radio modem and CDMA module (US only)



1. High-Speed Packet Access (HSPA) cellular module supports faster data rate and is backward compatible with GPRS/EDGE (GSM) technology.

Unpacking Your Receiver Kit

This section describes the documentation, standard kit components¹, and accessories (depending on your purchase) that accompany your receiver. When you unpack your receiver kit, verify you received the items listed in this section. If any items are missing or damaged, contact your Topcon dealer or Topcon technical support. See “Getting Technical Support” on page 6.

Standard Kit Components¹



Figure 1: Standard System Components that are Included with Your Receiver

1. Components in standard kits may differ based on your region. Contact your local Topcon dealer to inquire about items included in your regional standard kit and accessories that are available with the receiver.



The GPS+ Software CD includes USB drivers, which you need to install to use the USB port for communications.

Accessories

Topcon offers a wide variety of accessories¹ (see Figure 2) specially designed to improve system flexibility and job site efficiency. For more details on the optional accessories available for GR-5, contact your Topcon dealer.



Figure 2: Receiver Accessories

1. For more detailed information, see “Accessories” on page 4.

Technical Documents

The GR-5 Manual CD includes two manuals (listed below) that help you set up and use your new receiver quickly and efficiently.

- *GR-5 Operator's Manual* – An on-screen help document that contains detailed information on how to use your new receiver.
- *Topcon Receiver Utility (TRU) Online Help*– An on-screen help document embedded in the software that contains detailed information on how to use the TRU software. For more information about the TRU software, see “Using Topcon Software With Your Receiver”.

Using Topcon Software With Your Receiver

Use the GR-5 receiver in conjunction with the Topcon Receiver Utility (TRU) and MAGNET Field™ or Pocket-3D applications for a precision positioning solution. Topcon software enables you to configure the receiver and other external devices, manage files, collect data, and perform survey and construction work flows.

The Topcon Receiver Utility (TRU) is a hardware configuration software for receivers and peripheral devices. You can install it on desktop computers and data controllers. This program is provided on the GPS+ Software CD that accompanied your receiver. A TRU help document is provided on the GR-5 CD.

Topcon's MAGNET Field™ software for data controllers provides real-time communication, cloud storage, data collection and exchange, and field solutions, such as topo, staking, roads, calculations, and more.

Pocket-3D is a program that runs on data controllers with Windows CE® and mobile platforms. Pocket-3D simplifies data collection, allowing you to check cuts and fills, layout points and survey all or part of the job site quickly and efficiently. Contact your Topcon dealer for more information about Topcon field data collection software for the surveying and construction markets.

Getting Technical Support

Before contacting a Topcon customer representative about any problems with the receiver, see “Troubleshooting” on page 65 for some solutions that may fix the issue.

Contact your local Topcon dealer or visit the Topcon Total Care Web site (www.topconcare.com) for technical support.



For quick and effective support, provide a detailed description of the problem.

When contacting Topcon for technical assistance, provide the following information for better and faster service:

1. A description of the following:
 - Field operation that was being performed when the problem occurred
 - Details of the unexpected behavior, symptoms, and any error messages that precede or follow the problem
 - Problem occurrence frequency or patterns
2. Receiver information and configuration settings. For receiver information, click **Information** in TRU, select **Save to File**, enter a file name, and save it to the computer.
3. Specifications of mobile devices and computers used in the field or office exhibiting the problem. These specifications should include model information, version number, operating system information, memory and storage capacity, etc.
4. Information about the system software, including the version number and steps to reproduce the problem.
5. A description of the field environment and/or observation conditions when the problem occurred.

Website

The Topcon website provides current information about Topcon's line of products. The support area of the website provides access to Topcon field and office software, manuals, frequently asked questions, and so forth. To access the Topcon website, visit www.topconpositioning.com.

The Topcon's TotalCare web site also provides complete support, such as news, updates, reminders, training, live Webinars, and customer service to help you get the information you need. Visit www.topconcare.com.

Getting Acquainted

The GR-5 receiver enclosure is fully sealed and incorporates the GNSS receiver board, antenna, batteries, memory storage, and wireless communication device.

Receiver Overview

The upper portion of the receiver contains the GNSS antenna, which is enclosed by the radome and securely surrounded by a shock-absorbing rubber bumper. The receiver's magnesium alloy lower enclosure features an easy-to-operate display panel, detachable batteries, quick release mounting socket, and data ports.

The GR-5 receiver has a highly-visible display panel with single-button operation. The display panel enables you to view the receiver's operational status. For more information, see "Display Panel Operations" on page 19.

You can locate regulatory and product identification information on the two receiver labels, which are located inside of the battery compartments. The product identification label contains the serial number and part number.

Cables

The GR-5¹ package includes a power supply cable, a USB cable, and a power adapter. Table 1 describes the cables included with your receiver, depending on your regional standard kit configuration. Make sure to contact your local Topcon dealer to inquire about standard items included in your receiver kit.



Align the keyways when connecting the power/serial cable to the receiver port. Turn the cable lock clockwise until it clicks to secure the cable in place. To disconnect the cable, turn the lock counter-clockwise, and then gently remove the cable.

Table 1. Receiver Cables

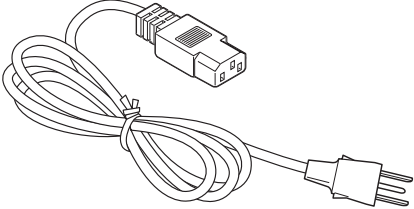
Cable Description	Cable Illustration
<p>Power Cable Connects the power supply unit to a grounded outlet. U.S.: p/n: 14-008052-01 Europe: p/n: 14-008054-01 Australia: p/n: 14-008053-01 Brazil: p/n:1000475-01</p>	

1. Components in standard kits may differ based on your region. Contact your local Topcon dealer to inquire about items included in your regional standard kit and accessories that are available with the receiver.

Table 1. Receiver Cables

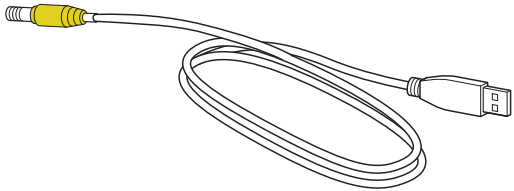
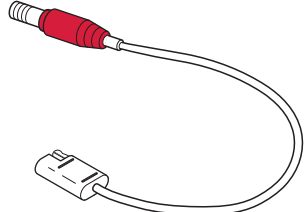
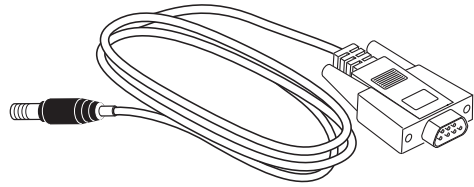
Cable Description	Cable Illustration
<p>USB Cable</p> <p>Connects the receiver to an external device (controller or computer) for data transfer and receiver configuration.</p> <p>p/n 14-008070-01</p>	
<p>Receiver Power/Charging Cable</p> <p>Connects the receiver and the power supply unit via SAE connectors for battery charging.</p> <p>p/n 14-008016-03</p>	
<p>Serial Cable</p> <p>Connects the receiver to an external device (controller or computer) for data transfer and receiver configuration.</p> <p>p/n: 14-008005-03</p>	

Accessories

Topcon offers a wide variety of accessories specially designed to improve system flexibility and job site efficiency. For more details about the available accessories, contact your Topcon dealer.

- **Power Supply Unit** (p/n 22-034101-01): charges the detachable batteries when connected to a grounded outlet. This unit converts the alternating current (AC) normally supplied from an electrical outlet to a direct current (DC) used to charge the batteries and/or power the receiver.



The power supply unit should only be used for charging the batteries. Do not use as a power source during surveying.

The power supply unit can either be connected to the charging cradle or directly to the receiver. For details, see the power related sections in “Power Supply Unit” on page 31.

- **The Modem Antenna:** The Spread Spectrum (FH915+) antenna is a reverse polarity TNC RF connection (p/n 30-030012-01) and a UHF antenna is a BNC connection (p/n 30-070003-01 UHF 410-440 or p/n 30-050503-01 UHF 450-470).
- **The 2m Fixed Height Tripod and Pole:** A heavy duty tripod (22-050501-01).
- **The universal tribrach and tribrach adapter**¹ (p/n 22-006008-01 and p/n 22-006009-011): are used to level the tripod and secure the receiver or antenna to the tripod.
- **The precision tribrach adapter:** is used to precisely center, align, and level the tripod over a point. The horizontal spacer (p/n 60419) inserts into the precision tribrach and allows the receiver to sit securely on the precision tribrach.

1. The universal tribrach and tribrach adapter is not needed when using the heavy duty tripod (22-050501-01).

- **The quick disconnect adapter** (p/n 02-850905-01): connects to the range pole for the receiver to slip into the top. Using the side clips, the receiver can be quickly connected to/disconnected from the range pole.
 - **A hand-held controller**: allows the GR-5 Base and Rover systems to be configured and monitored directly in the field. You can use the Topcon Receiver Utility (TRU) to configure the receiver and any Topcon field data collection software.
 - **MAGNET and Pocket 3D Software**: can be used to operate the receiver. See reference manual of TRU or Field data collection software for details on set up and operation.
 - **The ODU-to-alligator clips cable** (p/n 14-008097-01LF): connects the charging cradle or receiver to an auxiliary battery for powering the receiver during survey operations.
 - **The AA battery pack**: holds four AA batteries to provide a portable backup power source for the receiver. Due to variances in AA battery capacity, and the mode of the receiver and type of modem, the amount of time the receiver is powered varies.
-



Do not use rechargeable AA batteries.

Do not use the AA battery shell when the radio modem is in transmitter mode.

- **Cradle-to-receiver charging cable** (p/n 14-008072-01 (1.5m long) p/n 14-008072-02 (0.5 m long): Connects the receiver to the charging cradle for external power.
- **Battery Recharger** (01-050911-01): Charges the batteries. See “Charging the Batteries” on page 31.

Batteries

The receiver comes equipped with two detachable, rechargeable batteries for powering the receiver. For more information about using the batteries, see “Managing Power” on page 30.

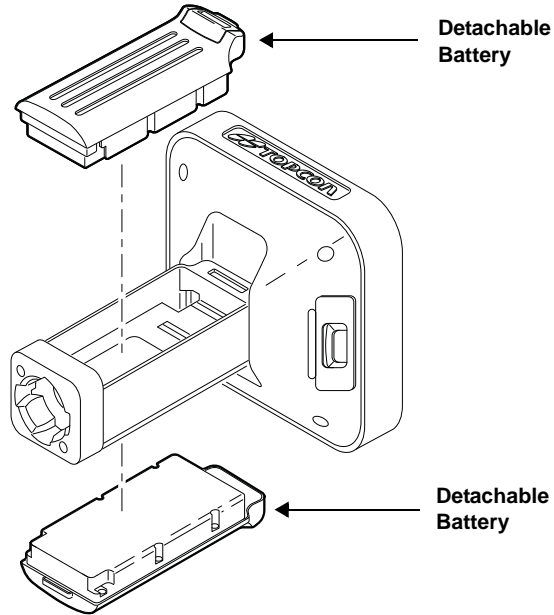
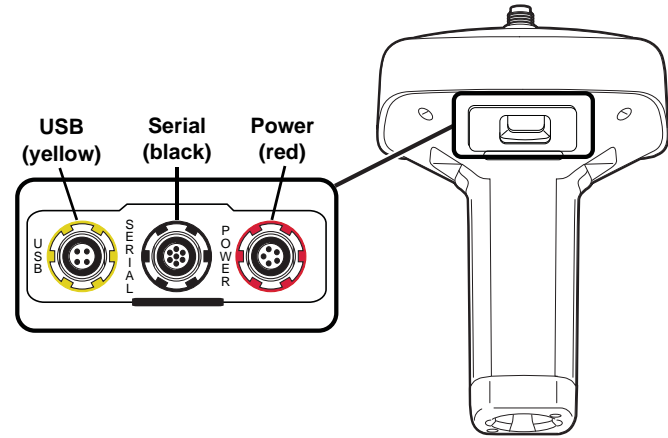

Figure 3: GR-5 Detachable Batteries

Data and Power Ports

The GR-5 has the following three ports:

- **USB** – rimmed in yellow; used for high-speed data transfer and communication between the receiver and an external device. The body of the connector on the corresponding cable is yellow.
- **Serial Port** – rimmed in black; used for communication between the receiver and an external device.
- **Power** – rimmed in red; used to connect the receiver to an external power source. This port can also be used to charge the batteries. The body of the connector on the corresponding cable is red.



External Radio Antenna Connector

The radio antenna connects to the external antenna connector on the GR-5 radome (Figure 4). The radio antenna uses a reverse polarity TNC or BNC connection depending on the installed radio modem.

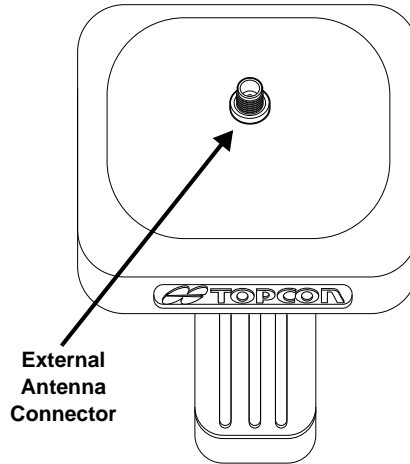

Figure 4: GR-5 Radome and External Antenna Connector

Bottom Connector

The bottom connector (Figure 5) connects the receiver to either a standard 5/8" thread pole/adaptor or the quick disconnect. The quick disconnect adapter (p/n: 02-850905-01) connects to the range pole for the receiver to slip into the top. Using the side clips, the receiver can be quickly connected to/disconnected from the range pole.

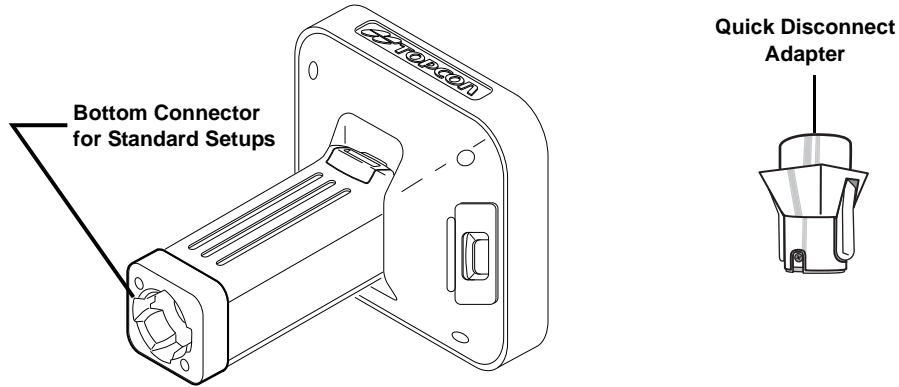

Figure 5: GR-5 Quick Connector

SD/SDHC and SIM Card Slots

The SD/SDHC and SIM card slots are located under the battery compartments near the base of the dome. For more information about the SD/SDHC card, see “Memory” on page 59. For more information about SIM cards, see “SIM Card Slot” on page 18.

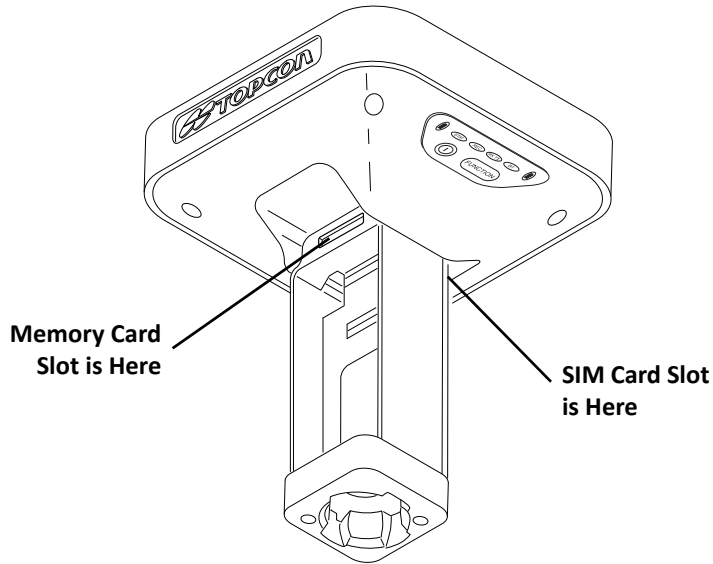

Figure 6: GR-5 Card Slots

SIM Card Slot

The SIM card slot is located to the right of the LED Display Panel inside the battery compartment. It enables you to install a standard SIM card into the receiver. Once installed, the SIM card provides a unique identification for the receiver's HSPA module and enables the receiver's HSPA functionality based on the subscribed services (the receiver board accesses the HSPA module, which accesses the SIM card). The SIM card usually remains inside the receiver. You can access the HSPA module, with the SIM card installed, via TRU for configuration purposes. A SIM card can be purchased from a local cellular provider.



The GR-5 receiver, equipped with a CDMA module, does not require a SIM card and is only approved to work on a Verizon® wireless network. Note the MEID # printed on the GR-5 unit or extracted from TRU, and call Verizon to activate service on the CDMA module. installed on the GR-5 receiver.

SIM Cards

The SIM card must have GPRS support to communicate over a TCP/IP network.

Installing the SIM Card

1. Make sure the receiver is turned off.
2. Remove the detachable battery to the right of the LED Display panel.
3. Carefully insert the SIM card, label-side up, into the SIM card slot located at the top of the battery compartment. Once the receiver is turned on, the receiver board will detect the SIM card, and it will be ready to use as needed.

Display Panel Operations

The LED display panel (Figure 7) enables you to control receiver power and data recording. The LEDs display the status of the satellite tracking, recording/memory capacity, Bluetooth connections, and batteries. This chapter describes the different LED blink patterns and what they mean.

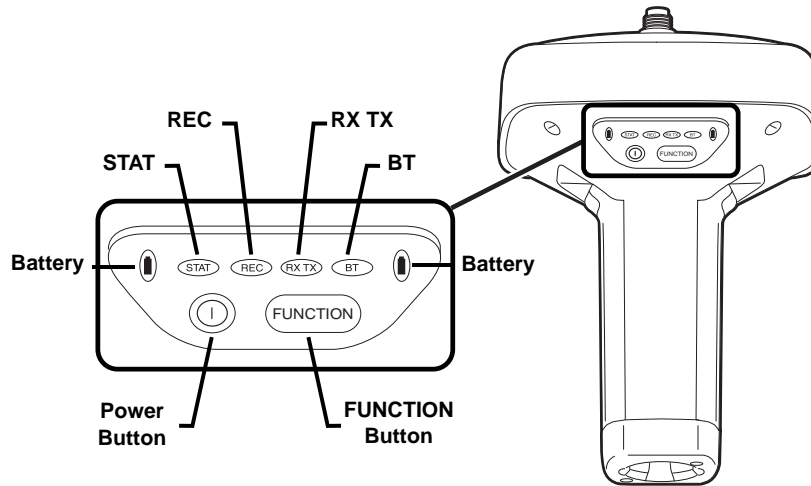

Figure 7: LED Display Panel

Power Button

The power button turns the receiver on and off. When turning the receiver on, press the Power button until the LEDs briefly flash. When turning off the receiver, press the Power button until the LEDs go out.

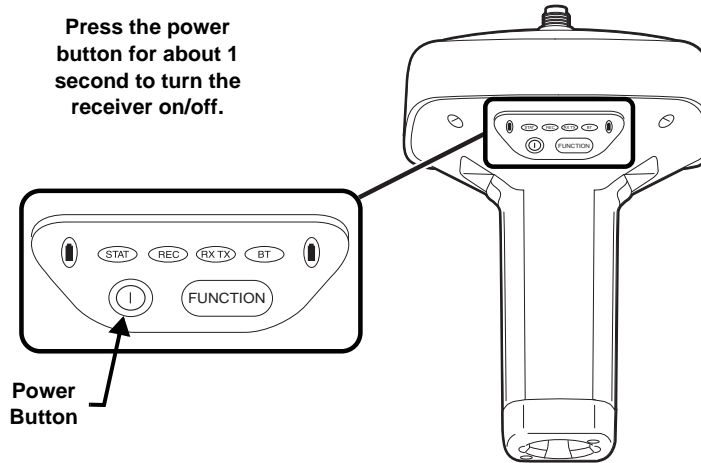

Figure 8: Power Button Functions



Receiver Status LEDs

There are four status LEDs to provide you information about the battery life, tracked satellites, memory capacity, and Bluetooth wireless connectivity. This section describes the color and behavior of each LED.

STAT LED

The tracking status LED displays the status of tracked satellites when the receiver is on.

Table 2. Status LED Patterns

LED Color	Description
	One blink per tracked GPS satellite.
	One blink per tracked GLONASS satellite.
	One blink means no satellite is being tracked.

REC LED

The recording LED indicates if data is being written to memory and warns if memory is available for recording. For a description of the REC LED status when using the FUNCTION button, see Table 7.

Table 3. Recording LED Patterns





Display	Description
	Green Blink: File logging is in progress. Each blink indicates data is being written to the SDHC card.
	Solid Orange: The receiver is changing modes.

Table 3. Recording LED Patterns

Display	Description
	Orange Blink: The file system is not accessible.
	Solid Red: A fault condition with the receiver (no more memory, no SDHC card inserted, a hardware problem, or an improper OAF).



For more information on REC LED patterns, see “FUNCTION Button/Logging Data” on page 26.

RX TX LED

This LED displays the status of the modem. Table 4 describes the LED colors and patterns for the different modems available for the GR-5 receiver.

Table 4. GR-5 LEDs

FH915/Digital II	
No Light	Modem is turned Off
Green Flashes (green LED, off, green LED)	Modem is in receiver mode



Table 4. GR-5 LEDs

Solid Green	A radio link has been established; modem is ready to receive data
Solid Green plus yellow (green LED, green LED + red LED)	Modem is receiving data (Yellow during actual reception)
Solid Red	Modem is in transmitter mode
Red Flashes (rapid red LED, off, red LED)	A fault condition has been detected
Red then Green (Red LED, off, green LED, off)	Modem is in command mode
GSM/HSPA	
Solid Yellow (Red LED + Green LED)	Modem is initializing
Green Flashes	The modem is on, registered on the network, and is waiting for incoming calls
Solid Red	A connection had been established
Green Blinks (DUHF II or SpSp)	The modem is in direct control mode (Daisy Chain)
Yellow flashes (green LED + red LED, off)	an error has occurred (initialization error, wrong PIN code etc.)

Bluetooth LED

The Bluetooth LED displays the status of the Bluetooth activity. Table 5 describes the activity.

Table 5. Bluetooth LED Patterns

LED Color	Description
	Blue Blink: Bluetooth is on and waiting for a connection.
	Blue Solid: A single Bluetooth connection is established.
	No light: Bluetooth is turned off.

Battery LED

The Battery LED indicates the remaining charge of each detachable battery. When an external power source is utilized, the Power button LED turns solid green and begins to blink if the batteries begin to charge. See Table 6 for more information.

Table 6. Battery LED Patterns







LED Color	Description
THE RECEIVER IS ON; USING BATTERY POWER	
	Slow Green Blink (5 sec.): The charge is greater than 85 percent.
	Slow Orange Blink (5 sec.): The charge is intermediate.

Table 6. Battery LED Patterns

LED Color	Description
	Slow Red Blink (5 sec.): The charge is less than 15 percent.
EXTERNAL POWER IN USE(POWER BUTTON LED SOLID GREEN);BATTERIES ATTACHED^{a,b}	
	Fast Green Blink (1 Sec.): The internal batteries are at greater than 85% capacity; the batteries are being charged.
	Fast Orange Blink (1 Sec.): The internal batteries are at greater than 15% capacity; the batteries are being charged.
	Fast Red Blink (1 Sec.): The internal batteries are at less than 15% capacity; the batteries are being charged.

a. The receiver is on or off.

b. You can also charge the batteries using the battery charging cradle. See page “Battery Charging Cradle” on page 32.

FUNCTION Button/Logging Data

This button switches the receiver between information modes and post-processing modes, starts/stops data recording, and changes the baud rate of the serial port to 9600. The FUNCTION button enables you to turn data recording on or off. See Table 7 to learn how to use the FUNCTION button.

Each time data recording is turned off or on, either a new file opens or data appends to a particular file.

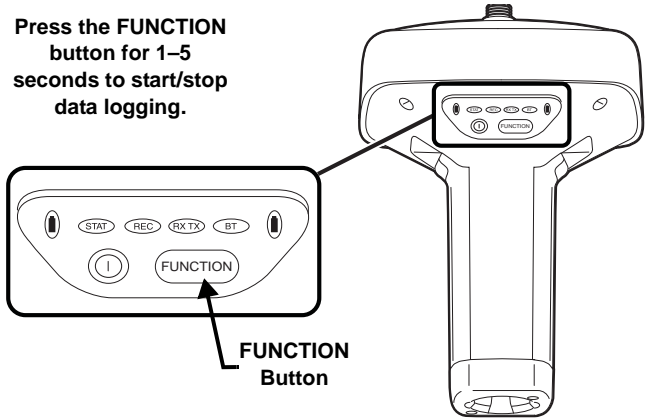

Figure 9: FUNCTION Button

Table 7. FUNCTION Button Operations and REC LED Status

FUNCTION Key	REC LED	Status
When data recording is off, and the FUNCTION key is...		

Table 7. FUNCTION Button Operations and REC LED Status (Continued)

FUNCTION Key	REC LED	Status
Not pressed	No light	No data recording.
	Orange blink	Internal file system test in progress.
	Red	No free memory; hardware problem with data recording. No SDHC card.
Pressed for < 1 second	If FUNCTION key mode is "LED blink mode switch"	
	Orange	Release to change information mode.
	If FUNCTION key mode is "Occupation mode switch"	
	Orange	No function.
Pressed for 1–5 seconds	If FUNCTION key mode is "LED blink mode switch"	
	Green	Release to start data recording (post-processing occupation mode undefined).
	If FUNCTION key mode is "Occupation mode switch"	
	Green	Release to start recording (Kinematic or Static post-processing occupation mode).
Pressed for 5–8 seconds	Red	Release to turn serial port A baud rate to 9600 bps.

Table 7. FUNCTION Button Operations and REC LED Status (Continued)

FUNCTION Key	REC LED	Status
Pressed for > 8 seconds	No light	No function.
When data recording is on, and the FUNCTION key is...		
Not pressed	Red	No free memory; hardware problem with data recording.
	If FUNCTION key mode is "LED blink mode switch"	
	Green	Data recording started (post-processing occupation mode undefined).
	If FUNCTION key mode is "Occupation mode switch"	
	Green	Data recording started (Kinematic post-processing occupation mode).
	Orange	Data recording started (Static post-processing occupation mode).
Pressed for < 1 second	If FUNCTION key mode is "LED blink mode switch"	
	Orange	Release to change information mode.
	If FUNCTION key mode is "Occupation mode switch"	
	Orange	Release to toggle between Static and Kinematic post-processing modes.

Table 7. FUNCTION Button Operations and REC LED Status (Continued)

FUNCTION Key	REC LED	Status
Pressed for 1–5 seconds	No light	Release to stop data recording.
Pressed for 5–8 seconds	Red	Release to turn serial port A baud rate to 9600 bps.
Pressed for > 8 seconds	No light	No function (data recording still on).

Managing Power

This chapter describes how to power the receiver, charge the detachable batteries, and use an external power source.

Turning On/Off the Receiver

To turn on the receiver, press and hold the power button for more than one second until the LEDs briefly flash. When the receiver is turned on, the receiver's channels initialize and begin tracking satellites from multiple constellations (depending on the receiver's supported features and current OAF).

To turn off the receiver, press and hold the power button for more than one and less than four seconds (until both the STAT and the REC LEDs are off).



The receiver will draw a small amount of power from the batteries when it is turned off. If the receiver is placed in storage for a long period, such as a few months, the batteries may become fully discharged. You will need to use an external power supply or recharge the batteries before use.

Powering the Receiver

The receiver is powered by the detachable, rechargeable batteries or an external power source connected to the power port. If an external power source is connected, the receiver draws power from it over the battery.

Detachable External Batteries

Each detachable battery provides between 5 and 10 hours of operation, depending on the receiver mode.

To check the status of the detachable batteries, view the BATT LED or check the status using available Topcon software.

Charging the Batteries

The batteries are shipped from the factory without power. Fully charge the batteries before surveying. You can use the power supply unit or the battery charging cradle to charge the batteries.

Power Supply Unit

The power supply unit (p/n 22-034101-01) charges the external batteries when connected to a grounded outlet. This unit converts the alternating current (AC) normally supplied from an electrical outlet to a direct current (DC) used to charge the batteries and/or power the receiver.



The power supply unit is designed for indoor use only. Do not use in a damp or a wet environment. Do not expose the power supply to rain or snow. It should only be used for charging the batteries. Do not use as a power source during surveying.

You can connect the power supply unit to the charging cradle or directly to the receiver. See “Power Supply Unit” on page 32. The power supply has the following specifications:

- input voltage – between 100 and 240 V AC
- frequency of input power – between 50 Hz and 60 Hz
- output voltage – 12 V DC@2.5 A (30 W)

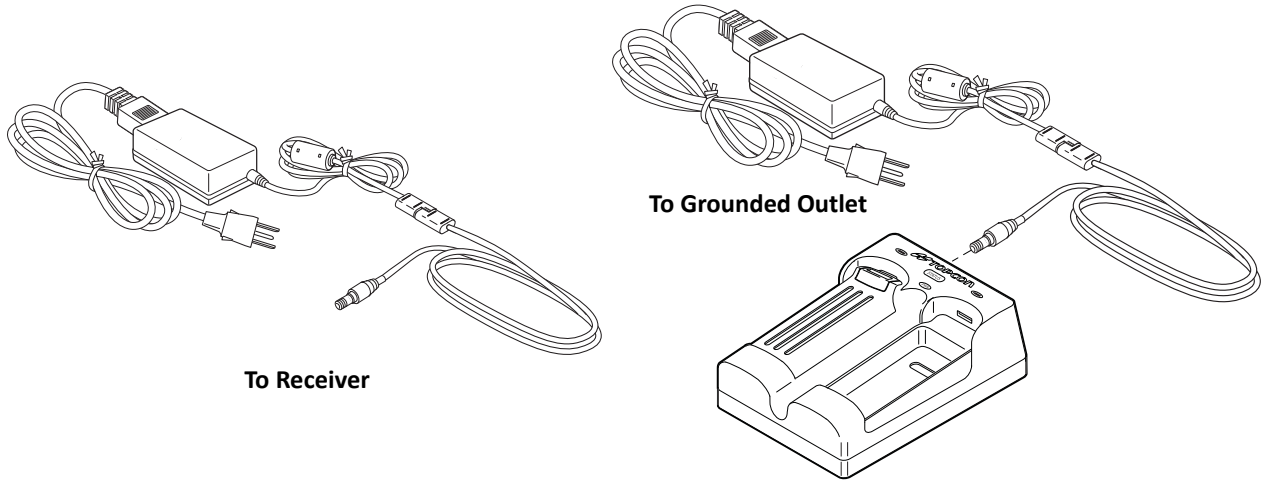

Figure 10: Power Supply Unit

Battery Charging Cradle

The battery charging cradle (Figure 11) connects to a standard power outlet using the power adapter cable and power cable/power supply unit.

The charger has two ports, one button, and three LEDs.

- The two ports connect the charger to either a receiver or an external power source. The ports charge or drain the batteries simultaneously.

- The STATUS button activates the battery LEDs. Press **STATUS** to display the amount of charge for the corresponding battery.
- The two battery LEDs display the percentage of charge in the attached battery:
 - A green light indicates a charge greater than 85%.
 - An orange light indicates an intermediate charge.
 - A red light indicates a charge of less than 15%. Recharge or replace the battery as soon as possible.
- The power LED lights up when the charger is connected to an external power source; such as an electrical outlet or another power source (12 volt battery).

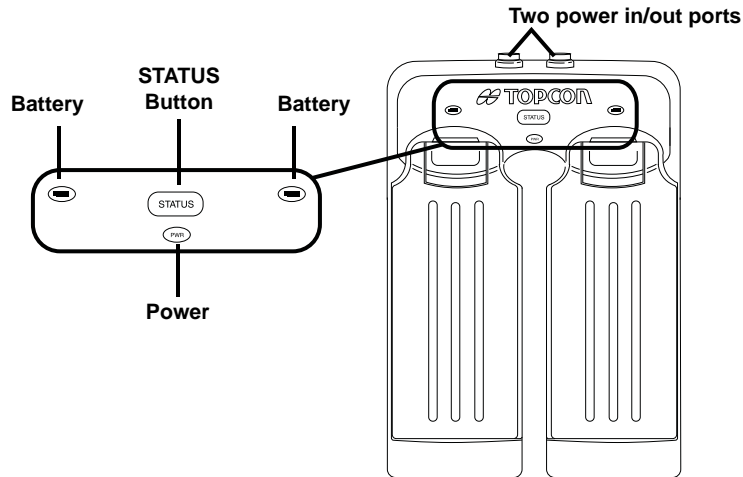

Figure 11: Battery Charger Cradle with Batteries

You can also attach the battery charger to a tripod, a belt, or an RTK pole to provide external power to the base station or rover.

Before using the GR-5, fully charge the batteries for maximum operating time.

Battery Charging Temperatures

Charge the batteries only in temperatures between 32°F (0°C) and 113°F (45°C).

An optimal charging temperature is between 50°F (10°C) and 77°F (25°C). If possible, charge the batteries within this temperature range.

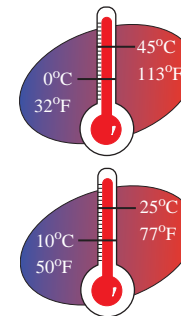

Charging Procedure

There are two ways to charge the receiver's detachable batteries:

- while they are attached to the receiver
- while they are attached to the charging cradle

If the batteries are attached to the receiver or to the charging cradle, in approximately six hours the batteries will be simultaneously fully charged.

The Li-Ion batteries used in the battery packs should run at no less than 80% capacity after 500 charging cycles. You do not need to drain these batteries before recharging.

To charge the batteries using the power supply unit:

1. Plug the receiver-to-SAE power cable into the receiver's power input port.
2. Connect the receiver-to-SAE power cable and the power supply-to-outlet cable to the AC adapter.
3. Plug the power supply-to-outlet cable into an available outlet. The batteries are fully charged after approximately 6 hours.

To charge the batteries using the charging cradle:

1. Remove the batteries from the receiver and insert them into the charging cradle.
2. Connect the power cable to the power supply unit.
3. Connect the SAE connectors on the power adapter cable and power supply unit.
4. Connect the power adapter cable to one of the ports on the charging cradle (either port will charge both/either battery).
5. Plug the power supply to an available outlet. The batteries are fully charged after approximately 6 hours.

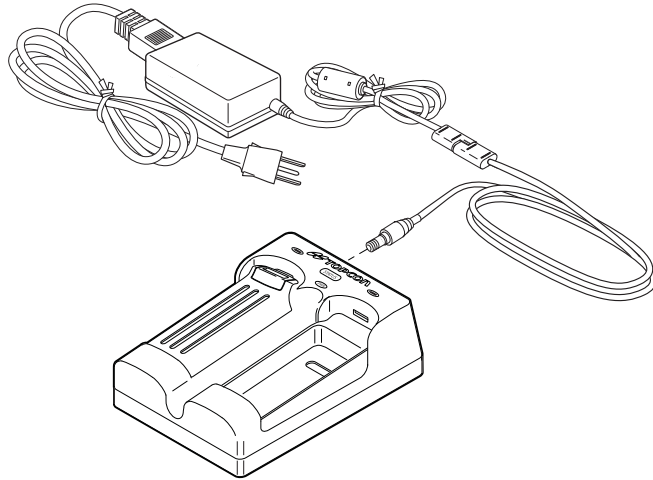
**Figure 12: Charging Batteries**

Leaving the Batteries on Charge

The batteries can be safely left in the receiver or the charging cradle once charging is complete. Doing so will not overcharge or damage the batteries.

The batteries can also be attached/detached to/from the receiver or charging cradle at any time without harming the batteries, the receiver, or the cradle. When returning the batteries to the receiver or cradle, charging is automatically resumed.

Attaching the Batteries

To attach the batteries to the GR-5 (Figure 13):

1. With the battery slightly tipped, place the bottom of the battery into the bottom of the battery compartment.
2. Gently push the top of the battery into the battery compartment until it snaps into place. Make sure that the clip at the top of the battery completely snaps into place.

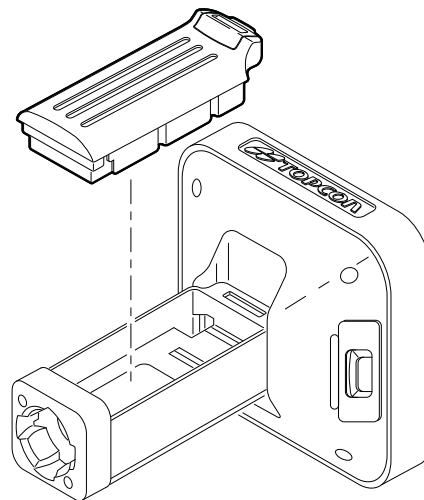

Figure 13: Inserting the GR-5 Batteries

Detaching the Batteries

To detach the batteries from the GR-5, so that they can be charged or replaced:

Using the clip at the top of the battery, gently pull down and out to detach the battery from the receiver (Figure 14).

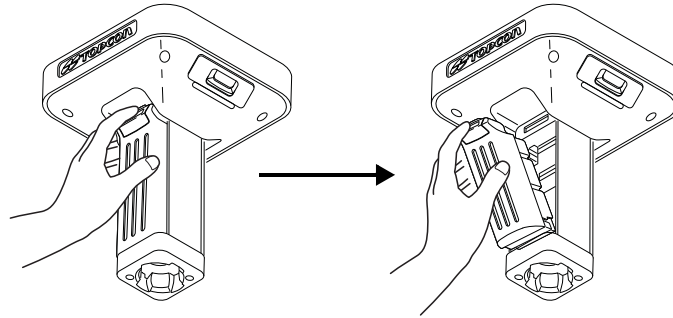

Figure 14: Detach the GR-5 Batteries

Assembling the AA Battery Shell

To assemble the AA battery shell to the GR-5 (Figure 15):



Do not use rechargeable AA batteries.

Do not use the AA battery shell when the radio modem is in transmitter mode.

1. Slide the back cover of the AA battery shell down and lift off.

2. Insert four AA batteries as shown on the inside of the shell (and in Figure 15 below).
 - The batteries on the left lay with the positive end towards the bottom of the shell.
 - The batteries on the right lay with the positive end towards the top of the shell.
3. Replace the back cover of the shell.

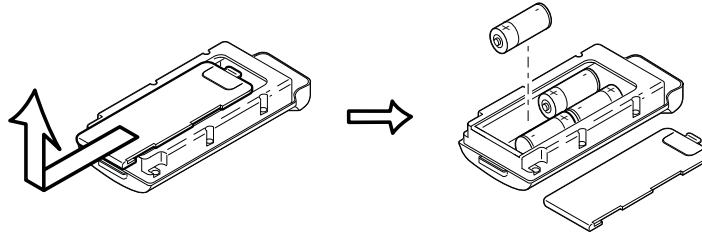

Figure 15: Remove Cover and Insert AA Batteries

4. Insert the AA battery shell into the battery compartment of the receiver as shown in Figure 13 on page 4-36.

Surveying While Charging

The user can execute any kind of surveying while charging the internal batteries attached to the GR-5 without degradation of performance.



While charging, make sure the air temperature is between +32 °F (0 °C) and +113 °F (+45 °C). This is important to prevent serious damage to the batteries, the receiver or injury to persons.

Changing the Batteries while Surveying

It is safe to change a depleted battery with a fully charged one while surveying (i.e., on the fly) without turning off the receiver. Before doing this, make sure the other battery has enough charge to power the receiver while changing the depleted battery. The surveying will not be disrupted. If needed, repeat this procedure for the second battery.

Using an Auxiliary Power Source

In addition to the detachable batteries, you can connect the receiver to an external power source, such as a vehicle battery with 9 to 21 VDC, to operate the receiver and for continuous use of the receiver if the detachable batteries become discharged.



Power input greater than 21 VDC could damage the receiver.

To connect the receiver to an auxiliary battery (Figure 16 on page 4-40):

Use the ODU-to-alligator clips cable (p/n 14-008097-01LF) to directly connect the auxiliary battery and the receiver's power port (without SAE).



When powering the receiver using external batteries, set the charger mode to Off; otherwise, the detachable batteries will also charge, causing operation time to decrease.

1. Connect the ODU-to-alligator clips cable to a 12-volt battery.
2. Connect the ODU-to-alligator clips cable to the receiver's power port.

3. Turn on the receiver.



**From Receiver to Auxiliary Battery
Using ODU-to-Alligator Clips Cable**

Figure 16: Connect an Auxiliary Battery and the Receiver

A single external 12 V, 2.3 A*h battery should run the receiver and modem for about 9 hours and the receiver for 13 hours.

To connect the receiver to the charging cradle (Figure 17):

The charging cradle with extra batteries hooks onto a tripod or belt for a convenient power supply for the receiver. The part number for the receiver-to-charger cradle cable is 14-008072-01 or 14-008072-02.

1. Connect one end of the cradle-to-receiver cable to the charging cradle.
2. Connect the other end to the power port on the receiver.



The Batteries in the Charging Cradle do not Charge the Internal/Detachable Batteries. The Charging Cradle Powers the Receiver

Figure 17: Connect the Charging Cradle and Receiver

Insufficient Power

If the batteries become fully discharged and an external power supply is not connected, the receiver will shut down and automatically save recorded files. To avoid disruptions, check the BAT LED on the display panel for the battery charge status. See “Battery LED” on page 24 for more information.

If the receiver shuts down due to insufficient power, the receiver and all communication ports become de-activated.

To restore power to your receiver and turn it back on, do one or all of the following:

- Recharge the batteries.
- Make sure the power cable is correctly connected to the receiver’s port.
 - a. Align the keyways when connecting the power/serial cable to the receiver port.
 - b. Turn the cable lock clockwise until it clicks to secure the cable in place.
 - c. To disconnect the cable, turn the lock counter-clockwise, and then gently remove the cable.
- Connect the receiver to a different power source.



Power supplied to the receiver should match the specifications provided by Topcon on the product. Failure to comply with these specifications may damage the receiver. See “Specifications” on page 75.

Configuring the Receiver

The sections in this chapter describe receiver options, and how to load a new Option Authorization File (OAF), update firmware, and perform a factory reset. To do this, you will need to use the Topcon Receiver Utility (TRU) software that was supplied on the GR-5 CD. For information about installing the software, see the *Topcon Receiver Utility (TRU) Online Help* embedded in the software.

Viewing Receiver Information

In the Topcon Receiver Utility (TRU), the **Receiver Info** window displays basic receiver information, such as hardware and firmware versions, RAM size, receiver ID, serial number, etc.

To open the Receiver Info window:

1. Connect the receiver to a computer and open TRU.
2. In TRU, connect to the receiver.
3. Click **Device ▶ Application Mode ▶ Receiver Managing**.
4. Click **Device ▶ Connect**.
5. In the **Connection Parameters** window, select the correct serial port, and click **Connect**.
6. In the TRU main window, click the **Information** icon. The **Receiver Info** window (Figure 18) appears.

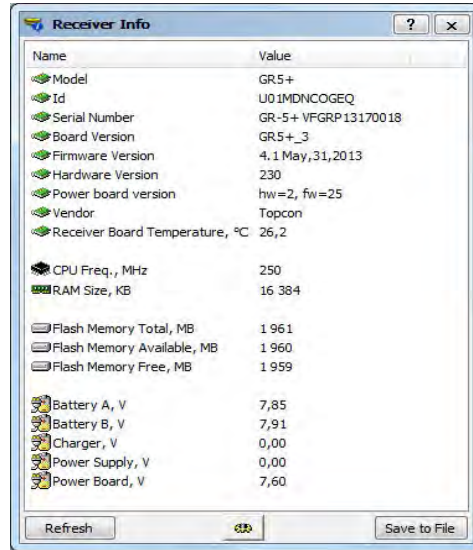

Name	Value
Model	GR5+
Id	U01MDNCOGEQ
Serial Number	GR-5+ VFGRP13170018
Board Version	GR5+_3
Firmware Version	4.1 May,31,2013
Hardware Version	230
Power board version	hw=2, fw=25
Vendor	Topcon
Receiver Board Temperature, °C	26,2
CPU Freq., MHz	250
RAM Size, KB	16 384
Flash Memory Total, MB	1 961
Flash Memory Available, MB	1 960
Flash Memory Free, MB	1 959
Battery A, V	7,85
Battery B, V	7,91
Charger, V	0,00
Power Supply, V	0,00
Power Board, V	7,60

Figure 18: TRU – Receiver Info



The GR-5 receiver, featuring Vanguard technology, is referred to as the GR-5+ to differentiate from the GR-5 receiver with an older receiver board.

Loading New Firmware

Receiver board firmware is released as a compressed file that you download and decompress. This file contains the following two files:

- ramimage.ldr – the Receiver board RAM file
- main.ldr – the Receiver board Flash file

To upload firmware files to the receiver:

1. Connect the receiver to a computer using the Power and Serial cable receiver accessory (p/n: 100182-01).
2. To connect to the receiver in TRU:
 - a. Click **Device ▶ Application Mode ▶ Firmware Loader**.
 - b. Click **Device ▶ Connect**.
 - c. In the **Connection Parameters** window (Figure 19), select **Serial Port** and the port name, and then click **Connect**.

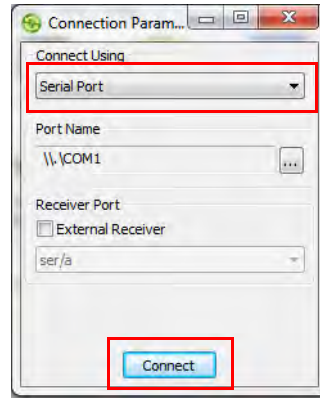



Figure 19: Connection Parameters Window

3. Click the **Firmware Loader**  icon in the TRU main window. The **Firmware Loader** window (Figure 20) displays. This window enables you to upload firmware files to the connected receiver.
4. Make sure **Receiver/Modem/Bluetooth** is selected in the **Device** field.
5. (Recommended) Select **Soft Break** as the **Capture Method**.
6. Browse for and select the receiver board's RAM and Flash files (Figure 20).

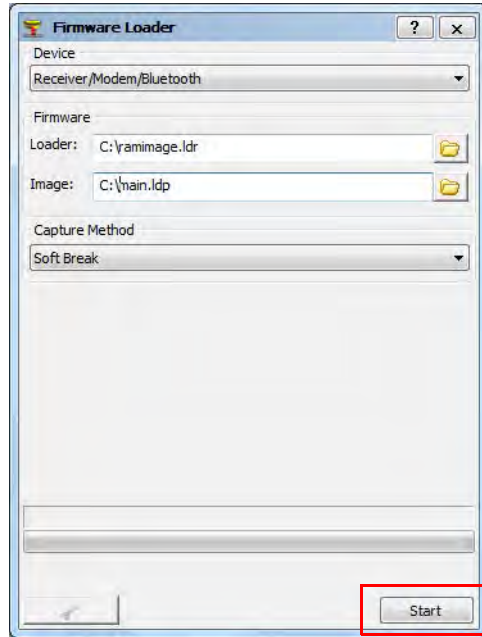

Figure 20: Upload Firmware Window

7. Click **Start** to upload the selected files.
8. Click **OK** to continue uploading new firmware to the receiver (see Figure 21).

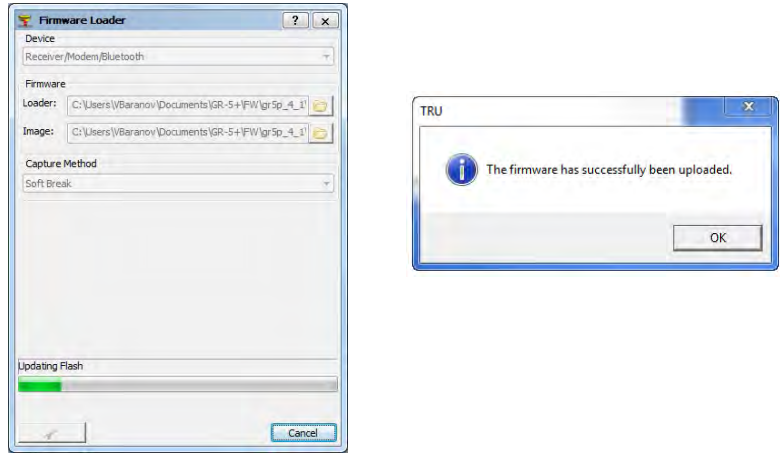

Figure 21: Finishing Firmware Upload

About the OAF

Topcon issues an Option Authorization File (OAF) to enable the specific options that you purchased. Topcon's OAF system allows you to customize and configure the receiver according to your particular needs, therefore purchasing only the options you require.

The GR-5 receiver typically ships with an OAF as per initial purchase of the receiver kit configuration. There are several upgrade options available with the receiver that can extend the receiver's functionality to better suit your job requirement. Examples of upgrade options are listed below:

- GLONASS L1, L2 signal tracking
- GPS L5 signal tracking
- RTK and update rate 20, and 50 Hz (10 Hz standard)

Contact your Topcon dealer or a representative for a complete listing of available options and pricing information.

Checking the Receiver's OAF

To use TRU to view the status of the receiver's options:

1. Connect the receiver to a computer and open TRU. See the *Topcon Receiver Utility (TRU) Online Help* for more information about connecting the receiver to a computer.
2. In TRU, connect to the receiver.
3. Click the **Options**  icon in the main window. The **Receiver Options** window (Figure 22) displays, so you can view the current authorization options and upload new ones.

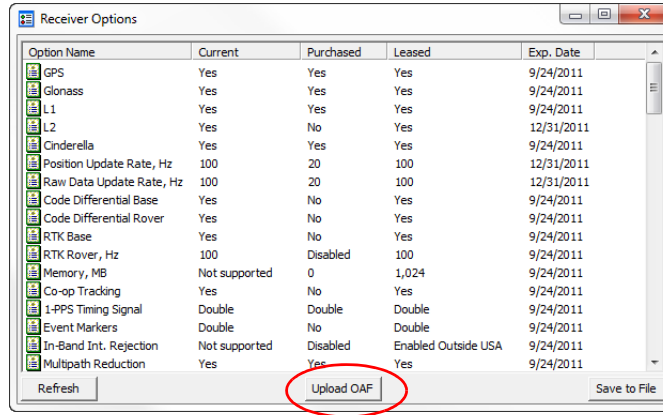

Figure 22: Receiver Options

Loading an OAF

Topcon dealers provide customers with OAF files. For any OAF related questions, e-mail Topcon at options@topcon.com and include the receiver's ID and serial number. To obtain these numbers, see "Viewing Receiver Information" on page 43.

To load a new OAF:

1. Follow the steps in "Checking the Receiver's OAF" on page 49.
2. Click **Upload OAF** on the bottom of the **Receiver Options** window (see Figure 22).

3. Navigate to the location of the new Option Authorization File (Figure 23).

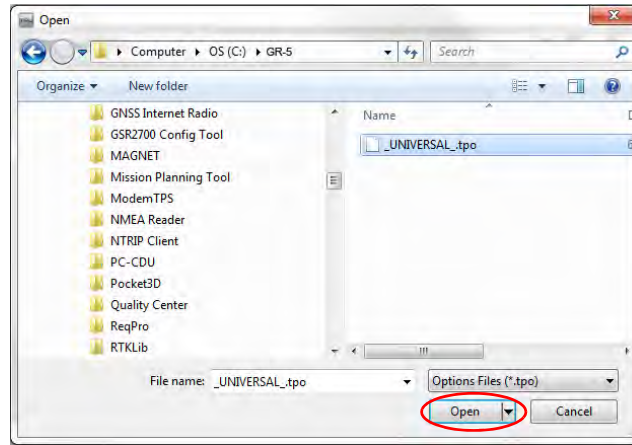

Figure 23: Load OAF

4. Select the appropriate file, and click **Open** (Figure 23).
Topcon's TRU initially checks to see if the selected file is compatible with the currently connected receiver. If you chose a file not intended for this receiver, the **Upload OAF** window displays an error icon next to the Receiver ID and disables the **Upload the File to the Receiver** button.

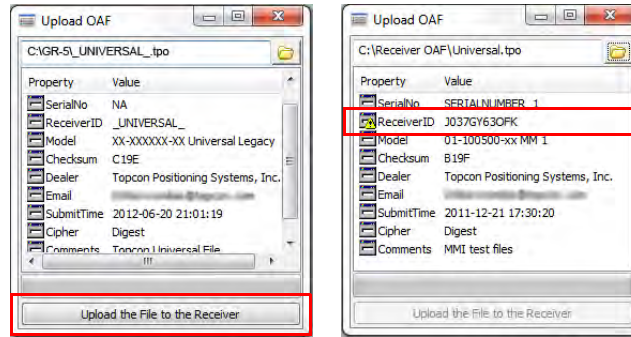

Figure 24: OAF Compatibility Check

- Press **Upload the File to the Receiver** (Figure 24) to start loading the file. If an OAF file is uploaded to the receiver, TRU will offer to reset the receiver to put new authorization options into operation (Figure 25).

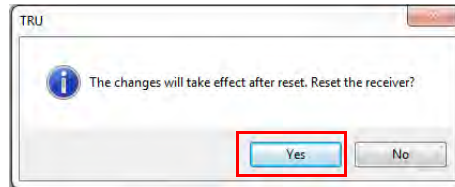

Figure 25: Reset the Receiver

- Click **Yes**.

Performing a Factory Reset

The receiver's Non-Volatile Random Access Memory (NVRAM) holds data required for satellite tracking, such as ephemeris data and receiver position. The NVRAM also keeps the current receiver's settings, such as active antenna input, elevation masks and recording interval, and information about the receiver's internal file system. A factory reset clears the receiver's NVRAM and restores the receiver's factory default settings.

Although a factory reset or clearing the NVRAM is not recommended as a common practice, there are times when it can eliminate communication or tracking problems.

After a factory reset, the receiver requires time to collect new ephemerides and almanacs (around 15 minutes).

A factory reset will not delete any files already recorded in the receiver's memory, and the NVRAM keeps information about the receiver file system.

There are two ways you can perform a factory reset: using TRU and using the LED display panel.

Using TRU to clear the NVRAM:

1. Connect the receiver to a computer, and open TRU. See the *Topcon Receiver Utility (TRU) Online Help* for more information about connecting the receiver to a computer.
2. In TRU, connect to the receiver.

- Click the **Tools** icon  in the main window.
The **Tools** window appears, enabling you to reset the receiver and clear the NVRAM.

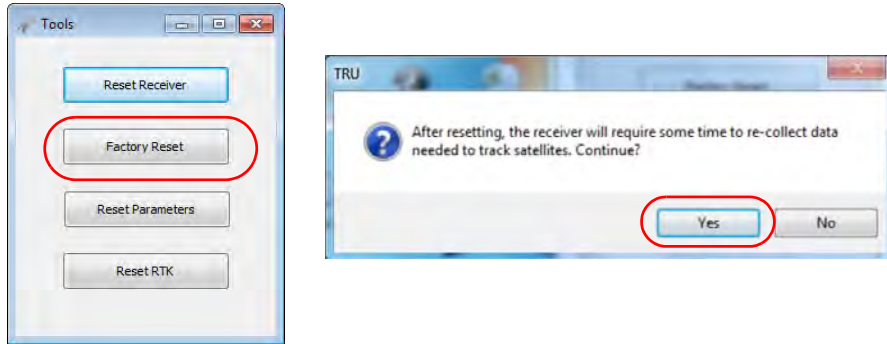

Figure 26: Tools Dialog Box

- Click **Factory Reset**, and click **Yes** to continue.

Using the LED display panel

- Press the Power button to turn off the receiver.
- Press and hold the FUNCTION button.
- Press and hold the Power button for one second, and then release it while continuing to hold the FUNCTION button.
- Wait until the STAT and REC LEDs turn green.
- Wait until the STAT and REC LEDs blink orange.
- Release the FUNCTION button while the STAT and REC LEDs blink orange.

Field System Setup

This chapter describes the field setup of your new receiver, so it is ready for use as a Base, network, RTK Rover, or static data collector.

Setting Up the Base Receiver

1. Install a heavy-duty tripod (p/n: 22-050501-01) over a known point. You do not need a universal tribrach and tribrach adapter when working with this tripod.
2. Attach the antenna to the modem antenna connector.
3. Level the tripod and tighten the screws.
4. Attach any other accessories as needed, such as a back-up power supply.
5. Measure the height of the receiver from the ground using the tape measure. See “Measuring Antenna Height” on page 57.
6. View the LED display panel for the receiver’s current status. See also “Display Panel Operations” on page 19.



Setting Up the Rover Receiver

1. If needed, attach the quick disconnect to the bipod/range pole.



Use a bipod during post-process surveys to ensure the antenna/receiver does not move during data logging.

2. Attach the receiver to the quick disconnect. Make sure the receiver locks into place.
3. If you are not using a fixed height rover pole, measure the height of the receiver from the ground. See “Measuring Antenna Height” on page 57.
4. Attach the antenna to the antenna connector.
5. Press the power button to turn on the receiver. The integrated wireless device in the receiver turns on when the receiver is powered.
6. View the LED display panel for the receiver’s current status. See also “Display Panel Operations” on page 19.

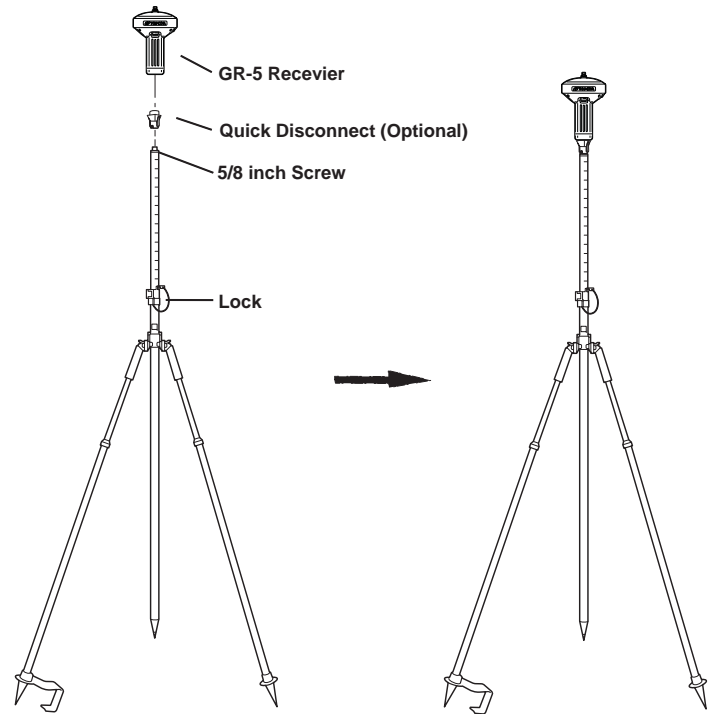

Measuring Antenna Height

The receiver calculates the coordinates of the antenna's phase center. To determine the coordinates of the station marker, specify the following:

- Measured height of the antenna above the station marker
- Method of measuring the antenna height
- Model of the antenna/receiver used

Any necessary antenna phase center adjustments, based on the antenna model, is automatically applied. This adjustment, when combined with accurately measured height and measurement methods, allows for correctly computed reference marker coordinates.

To accurately measure the antenna height:

1. Measure the antenna height above the control point or marker, either the slant height or the vertical height. You may either measure the vertical height to the Antenna Reference Point (ARP) located at the bottom of the receiver at the base of the mounting threads, or measure the slant height to the Slant Height Measurement Mark (SHMM) on the side of the receiver. For ARP and SHMM marks on the receiver, see Figure 27.
2. Record the antenna height, points name, and start time in the field notes.

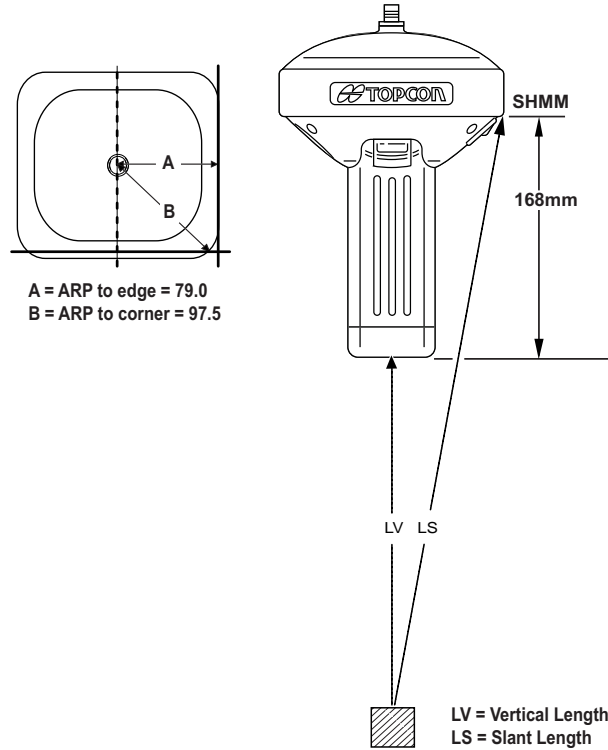

Figure 27: Antenna Height Measurement Points

This chapter provides general information about memory, recording data, downloading data, and removing files to free up memory space.

Memory

The GR-5 is equipped with an external SD/SDHC memory card slot. Although you may install an SD/SDHC card of any memory size into the slot, the receiver recognizes up to 32 GB of memory. For specific information, see “SD/SDHC Card Recommendations” on page 103. It is necessary to use recommended SD/SDHC cards to ensure accurate and reliable data logging and minimize any occurrence of data loss, card initialization, etc. The Optional Authorization File (OAF) controls the receiver’s memory capacity. As data is logged to the card, the REC LED displays the memory capacity status. See “REC LED” on page 21 for more information. To access the raw data files on the memory cards, see “Managing Files” on page 64.

SD/SDHC Card

The SDHC card slot is located to the left of the LED Display Panel inside the battery compartment and connects an optional SD/SDHC card to the receiver board to provide memory. Once installed, the SD/SDHC card usually remains inside the receiver. You can access the data that resides on the SD/SDHC card via the USB or serial port, or Bluetooth wireless technology (see “Managing Files” on page 64). A secure digital card can be purchased at a local computer supply store.

Installing the SD/SDHC Card

1. Make sure the receiver is turned off.
2. Remove the detachable battery to the left of the LED Display panel.
3. Carefully insert the SD/SDHC card, label-side down, into the card slot located at the top of the battery compartment. Once the receiver is turned on, the receiver board will detect the SD/SDHC card, and it will be ready to use as needed.

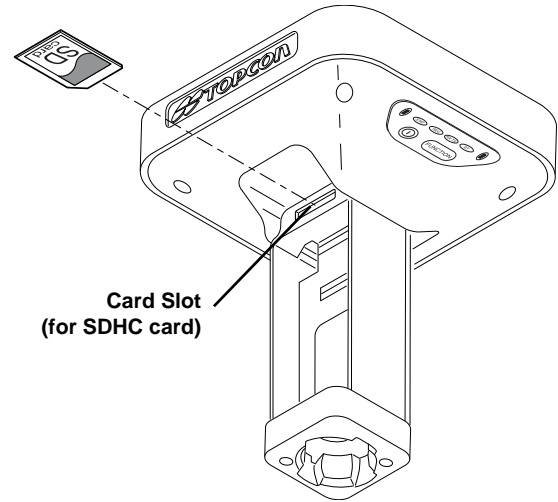

Always initialize the file system on the installed SD/SDHC card before the first use. The Initialization procedure is described below.

Initializing the File System

The GR-5 supports a removable SDHC memory card to log raw data files. The memory card must be initialized before its first use. Initializing the memory card while in the receiver ensures the card is formatted to the TPS proprietary file system (TPFS). This file system allows the receiver to create, store, retrieve, delete, and restore raw data files.

It is also advisable to re-initialize the memory card periodically (e.g., quarterly). This erases any data on the card, checks for bad blocks, and sets the card up afresh.

The user can use TRU to initialize the file system.

Initializing the File System Using TRU

1. Connect the receiver to a computer and run TRU.
2. Click the **File Explorer** icon to open the **File Explorer** screen.
3. On the **Files** tab, press and hold the right mouse button on the file line.
4. Click **Initialize File System**.



Initializing the file system of a connected receiver will erase all of the receiver's data files. A warning message will appear to confirm the operation.

Setting Recording Parameters

The Topcon Receiver Utility (TRU) software enables you to set logging parameters, such as logging rate and types of messages, in which to record data. This software is supplied on the GR-5 CD. See the *TRU Online Help* for more information. The GR-5 is compatible with any Topcon field software for configuration and recording raw data.

Logging Rates

The amount of memory used to log data depends on the logging rate. For more information about setting logging rate parameters, see the *TRU Online Help*.

Recording Data

You can log raw GNSS data to the receiver's SD/SDHC card and use the Topcon Receiver Utility (TRU) or MAGNET Office™ software to download the files to a computer.

To start or stop recording data, use the LED display panel or TRU:

1. Press the Power button to turn on the receiver.

2. Wait for the STAT LED to indicate satellites are being tracked. The STAT LED blinks green for GPS satellites and amber for GLONASS satellites. A short red blink indicates the receiver has not solved a position. Five or more satellites provide optimal positioning.
3. To begin recording, press and hold the FUNCTION button, and then release it (between 1 and 5 seconds) when the REC (Recording) LED turns green.
4. Make sure the REC light blinks green. This indicates that a file has opened and data collection has started. The REC LED blinks each time data is saved to the SD/SDHC memory card. If the REC light blinks red, the receiver has:
 - a hardware problem
 - no SD/SDHC card installed
 - an improper OAF (See “About the OAF” on page 49)
5. You can also select **File Explorer ▶ Logs ▶ Start** in TRU to begin recording data.
6. When you have finished recording, press and hold the FUNCTION button until the REC LED turns dark. You can also select **File Explorer ▶ Logs ▶ Stop** in TRU to end data recording.
7. To turn off the receiver, press and hold the Power button until all LEDs turn dark.

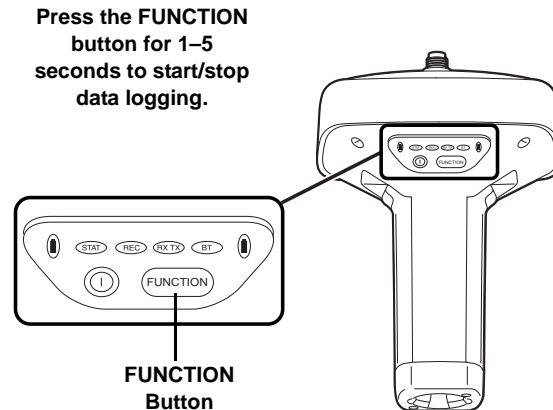

You can also log data using MAGNET Field software.

Managing Files

Raw data is recorded as time-tagged measurements in a single raw data file. Each file is recorded to the receiver's memory, and automatically given a name and a *.tps file extension. You can then transfer a file of collected data to a computer with file managing software, such as the Topcon Receiver Utility (TRU), which is supplied on the GPS+ CD. These programs allow you to use an automatic naming feature, enter file names, and delete files as necessary. For more information, see the *TRU Online Help* embedded in the software.

Downloading and Deleting Files

After completing a survey, download data files to a computer or a controller for storage, post-processing, or backup. The SD/SDHC cards hold a finite amount of files, so you will want to delete files to increase memory capacity.

When the memory is full, the receiver stops logging data, and the REC LED turns dark/off, indicating an error condition. Existing data is not overwritten.

To delete raw data files from the receiver, use a USB, serial, or Bluetooth connection to download the files to a computer. In TRU, you can select the files you want to delete from the receiver. See the *TRU Online Help* for more information.

Once a connection is established, you can download all or some files to a computer or controller and then use the File Explorer feature in Topcon Receiver Utility (TRU) to manage the raw data files. For more information about using TRU to download or delete files, see the *Topcon Receiver Utility (TRU) Online Help* embedded in the software.

••••• Troubleshooting

This chapter will help you diagnose and solve some common problems that may occur with the receiver.



Do not attempt to repair equipment yourself. Doing so will void the warranty and may damage the hardware.

Check This First!

Before contacting your local dealer or Topcon Technical Support, check the following:

- Check all external receiver connections carefully to ensure correct and secure connections. Double check for worn or defective cables.
- Check the receiver's internal batteries for a full charge.
- Check the power source for incorrectly connected cables, and ensure the power source is valid. See "Specifications" on page 75 for external power requirements.
- Check the software. Make sure the most current software version is downloaded onto the computer and the most current firmware is loaded into the receiver. Check the Topcon website for the latest updates.
- Check Topcon Technical Support (www.topconsupport.com) or Topcon Total Care (www.topcontotalcare.com) for the latest updates.

Then, try the following:

- Power on and off the receiver by pressing the Power button or by using TRU (**Tools ▶ Reset receiver**).

- Restore default settings by clearing the NVRAM. See “Performing a Factory Reset” on page 53. This restores the receiver’s parameters to the factory default settings and erases the almanac and ephemeris files. This action does not delete data files from the receiver memory.

If the problem persists, see the following sections for other solutions.

Powering Problems

The following are some of the most commonly encountered power problems.

The receiver does not power up

- The battery may be discharged.
 - Charge the battery overnight. See “Charging the Batteries” on page 31.
- If you are using an external power source, the cable may be disconnected or damaged.
 - Make sure the cable is securely connected and undamaged.
- The receiver may have a defective charger or defective battery.
 - If, after changing the battery or connecting an external power source, the receiver still does not power up, contact your local dealer or Topcon Technical Support for advice.

Receiver Problems

The following are some of the most commonly encountered receiver problems.

The receiver cannot establish a connection to a computer or external controller

Cable specific problems:

- The cable is not properly plugged in.
 - Unplug the cable, then securely and properly reconnect it to the receiver.
- The cable is damaged.
 - Use an undamaged cable. Contact a dealer to replace the cable.
- The USB driver is not installed.
 - If you are using a USB cable connection, make sure the USB driver, included on the GPS+ Software CD, is installed on the computer. You can also download the driver from the Topcon support Website at www.topcontotalcare.com.

Generic problems:

- The receiver port used for connection is not in Command mode.
 - a. Connect the receiver to a computer and open TRU (see “Connection” in the *Topcon Receiver Utility (TRU) Online Help* embedded in the software).
 - b. Click **Receiver Settings ▶ Ports**.
 - c. Change the **Input Mode** for the port used for connection to **cmd**.

The receiver does not lock on to satellites for a long period of time

- The corresponding receiver options may be disabled or expired (L1/L2, GPS/GLONASS must be on to track satellites).
 - Order a new OAF with the desired options activated to enable or extend validity of the corresponding receiver options. Contact a dealer or visit the Topcon website for details.
 - Refer to the “Receiver Managing” chapter of the *Topcon Receiver Utility (TRU) Online Help* for a detailed description of options.

The receiver tracks too few satellites

- If the survey is conducted near obstructions (tree canopy, tall buildings, and so forth).
 - Make sure the Multipath Reduction boxes have been enabled in the field data collection software.
 - a. Connect the receiver to a computer and open TRU (see “Connection” in the *Topcon Receiver Utility (TRU) Online Help* embedded in the software).
 - b. In TRU, connect to the receiver.
 - c. On the TRU main window, choose **Receiver Settings** ▶ **Tracking** ▶ **Adv** tab. Make sure the **C/A code multipath reduction** check box is selected.
- Move to an area free of obstructions, if possible.

The receiver cannot obtain Code Differential and/or RTK solutions

- Incorrect Base coordinates entered.
 - Specify the correct coordinates for the Base station using TRU or another suitable field data collection software.
- There could be some obstruction to the connection.
 - Clear all possible obstructions or relocate the Base so there is a “line-of-sight” path to the Rover.
- The corresponding receiver options may be disabled or expired.

- Order a new OAF with the required options activated to enable or extend validity of the corresponding receiver options.
- Refer to the *Topcon Receiver Utility (TRU) Online Help* for a detailed description of options.
- There are not enough common satellites. In order to obtain a fixed solution, the Base and Rover should track at least five common satellites.
 - Check the elevation masks of the Rover and Base receivers; they should be the same. To do this, on the TRU main window, choose **Receiver Settings ▶ Tracking ▶ Obs.**
 - Verify there is a clear view of the sky to allow sufficient satellite tracking.
- A discrepancy exists between the differential standards used at the Base and Rover receivers.
 - Ensure the Base and Rover receivers use the same corrections input/output format:
 - a. Connect the receiver to a computer and open TRU (see “Connection” in the *Topcon Receiver Utility (TRU) Online Help* embedded in the software).
 - b. In TRU, connect to the receiver.
 - c. On the TRU main window, choose **Receiver Settings ▶ Ports.**
 - d. Double-click on the port to be configured and make sure the input mode of the Rover matches the format of the Base output mode (i.e. RTCM3).
- Poor satellite geometry (PDOP/GDOP values are too high).
 - Conduct the survey where satellite visibility is better (low PDOP value).
 - Ensure the elevation mask is less than 10 degrees.
 - Increase the PDOP threshold. To do this, on the TRU main window, choose **Receiver Settings ▶ Tracking ▶ Obs.**
- The elevation mask is above 10 degrees.
 - Lower the elevation mask. To do this, on the TRU main window, choose **Receiver Settings ▶ Tracking ▶ Obs.**
 - Verify there is a clear view of the sky to allow sufficient satellite tracking.

- The modem battery is low.
- The specified baud rate is incompatible with the baud rates the modem supports. The baud rate is the rate at which the receiver transmits differential messages to the modem and vice versa.
 - Change the modem’s baud rate.
- The Base and Rover modems use different radio link parameters.
 - Configure the Base and Rover radio modems according to the procedures listed in the *TRU Online Help*.
- The distance between the Base and Rover is too far.
 - Close the distance between the Base and Rover.
 - Use repeaters to increase radio coverage.
- There may be a source of radio interference that disrupts radio communications.
 - Change the RF channel (if possible).
 - Removing the source of the jamming signal or relocate the radio antennas (if possible).

The receiver does not start logging data

- Make sure the recommended SD/SDHC card is being used and that the card is not damaged. See “SD/SDHC Card Recommendations” on page 103.
- Make sure the SD/SDHC card is properly inserted.
- The receiver’s memory is disabled or expired.
 - Make sure the memory option is enabled. For details, see the *Topcon Receiver Utility (TRU) Online Help*.
- The memory card does not have free space.
 - Download and/or delete data files to free up space for new files. See “Downloading and Deleting Files” on page 64.
 - The file system is not initialized. Initialize the File System on the SD card using TRU. To do this, on the TRU main window, choose **File Explorer ▶ Initialize File System**.

Bluetooth Problems

The following are some of the most commonly encountered error messages and other problems.

TRU error message: Can't find receiver

- The receiver is turned off.
 - Ensure the receiver has power and is turned on.
- Bluetooth is not turned on; the BT LED is off.
 - Reset the receiver to the factory default settings by pressing the Power button for 10 to 15 seconds.
 - You can also turn on power to Bluetooth using TRU. To do this, on the TRU main window, choose **Receiver Settings ▶ Bluetooth**.
- There is interference.
 - Move the receiver, controller, or computer to an unobstructed location.
- The receiver is too far away.
 - Move the devices closer together.
- The receiver is already connected via Bluetooth to another device.
 - Disconnect the receiver from the other controller or computer.
- The receiver port used for connection is not in Command mode.
 - a. Connect the receiver to a computer and open TRU (see “Connection” in the *Topcon Receiver Utility (TRU) Online Help* embedded in the software).
 - b. Click **Configuration ▶ Receiver ▶ Ports**.

- c. Change the **Input Mode** for the Bluetooth serial port used for connection to **cmd**.



This is the most common cause for this error message. Use TRU to double check the settings for the connection port.

TRU error message: Open COM# port failed: Access is denied

- Another application uses the computer port dedicated for connection.
 - Close the application, and then re-connect.
 - Connect the receiver via another, unused computer port.

After searching for available devices, none are discovered

- The receiver is not receiving power.
 - Check that the receiver is getting power and is turned on.
 - Check that the power cable is correctly attached to the port if one is being used.
 - Unplug the cable, then securely and properly reconnect it to the receiver.
 - If the power cable is damaged, contact a Dealer to purchase a new cable.

Can see the icon for the receiver’s Bluetooth module on the computer screen, but cannot connect to it

- Device security settings probably differ.
 - Make sure the Bluetooth enabled devices use the same security settings.
- Bluetooth module settings may have changed.

- a. If the settings are changed for the Bluetooth module, remove it from the list of discovered Bluetooth devices using the Bluetooth manager program (supplied with the device used to manage the receiver).
- b. Repeat the search.

TRU Problems

The following is the most commonly encountered TRU problem.

TRU cannot connect to the receiver

- The receiver is turned off.
 - Ensure the receiver has power and is turned on.
- If using a cable, the cable's connectors are improperly attached.
 - Check that the cable connector is attached to the correct serial port.
 - Unplug the cable, then securely and properly reconnect it to the receiver.
- If using a cable, the cable is damaged.
 - Use an undamaged cable.
 - Contact a dealer to purchase a new cable.
- If using Bluetooth wireless technology, the incorrect port is selected.
 - Use a computer or receiver that has Bluetooth wireless technology enabled/installed.
 - Make sure the computer and receiver use the correct ports for communication. For the GR-5 receiver, this is Bluetooth serial port A (btsp\A).

Cleaning and Storing the Receiver

- Use a clean cloth moistened with neutral detergent or water.
- Never use an abrasive cleaner, ether, thinner benzene, or other solvents.
- Always make sure the receiver is completely dry before storing it. Dry any moisture with a soft, clean cloth.

Getting Customer Support

If the troubleshooting hints and tips in this operator's manual fail to remedy the problem, contact Topcon Customer Support. For contact information, see "Getting Technical Support" on page 6.

Specifications

This chapter provides specifications for the receiver and its internal components.

General Details

Table 8 lists the receiver's general specifications.

Table 8. General Receiver Specifications

Physical	
Enclosure	Dust and water Ingress protected magnesium I-Beam housing
Color	Topcon Yellow / Gray bumper
Dimensions (mm)	158.1 (w) x 253 (h) x 158.1 (d)
Weight	1.88 kg with batteries, 1.44 kg without batteries
Antenna Type	Integrated Full Wave Fence Antenna™ ^a with Ground Plane and zero center
Battery	Two external, detachable
Controller	External

Table 8. General Receiver Specifications

Mounting	5/8-11, quick disconnect
Seals	Silicon (molding in color)
Keys	Two keys: <ul style="list-style-type: none"> • Power – On/Off • Function – start/stop data logging; switch information mode
LEDs	Six LEDs: <ul style="list-style-type: none"> • STAT – satellite and receiver status • REC – record and data status • RX TX – modem status • BT – Bluetooth wireless technology connection status • BATT (x2) – battery status
Environment	
Operating Temperature	<ul style="list-style-type: none"> • -30°C to +50°C Base* • -30°C to +60°C Rover* • -30°C to +60°C Base** • -30°C to +70°C Rover** • 0° to +45°C Charge mode* <p>* with detachable batteries ** with external power source</p>

Table 8. General Receiver Specifications

Storage Temperature	-20°C to +35°C with batteries -40°C to +75°C without batteries
Humidity	100%
Ingress Protection	Dust and water ingress protected (IP66)
Shock/Bump/Drop Rating	IEC 60068-2-29 IEC 60068-2-27 2 m pole drop to concrete
Vibration Rating	Compliance with MIL-STD 810F - 514.5 - Cat.24
Power	
External Batteries	Li-ion, 3900 mAh, 7.2 V; 2 batteries, detachable
Battery Size	132 x 55 x 35 (mm)
Battery Weight	220 g (1 battery)

Table 8. General Receiver Specifications

<p>Operating Time</p> <p>Average with modem “on” and 20 SVs tracked.</p> <p>Using new, fully-charged batteries, operating at room temperature and transmitting at 1 Hz rate.</p>	<p>For the GR-5 with FH915+ Modem:</p> <ul style="list-style-type: none"> • Receive-only mode – 14 hours • Transmitting at 250 mW – 12 hours • Transmitting at 1 W – 10 hours • GSM/GPRS in urban areas – 13 hours <p>For the GR-5 with Digital UHF II Modem:</p> <ul style="list-style-type: none"> • Receive-only mode – 14 hours • Transmitting at 0.5 W – 10 hours • Transmitting at 1 W – 8 hours • GSM/HSPA in urban areas – 12 hours <p>For the GR-5 with Any Modem:</p> <p>Modem off – 20 hours</p>
<p>External power</p>	<p>1 port</p>
<p>Input Voltage</p>	<p>9 to 21 V DC (for work)</p> <p>10 to 21 V DC (for charge battery)</p> <p>Maximum Charge Current <=2 Amp</p>

Table 8. General Receiver Specifications

<p>Power Consumption</p> <p>Average with modem “on” and 20 SVs tracked.</p> <p>Using new batteries and operating at room temperature.</p>	<ul style="list-style-type: none"> • Modem = off – 3.0W <p>FH915</p> <ul style="list-style-type: none"> • Receive-only mode – 4.3 W • Modem transmitting at 250 mW – 5.2 W • Modem transmitting at 1 W – 7.6W <p>Digital UHF II</p> <ul style="list-style-type: none"> • Receive-only mode – 4.3 W • Modem transmitting at 0.5 W – 6.4 W • Modem transmitting at 1 W – 7.8 W
<p>Battery Charge</p>	<p>Connect the AC adapter to charge the internal battery. Available run charge when connected to external battery.</p>
<p>Charging Time</p>	<p>Approx. 6 hours for full charge</p>
<p>On-board</p>	<p>Backup battery for timekeeping and almanac data storage; minimum 10 years of operation</p>

Table 8. General Receiver Specifications

GNSS	
Number of Channels	226-Channel Vanguard Technology™ with Universal Tracking Channels
Tracked Signals ^b	GPS: L1, L1C, L2, L2C, L5 GLONASS: L1, L2 Galileo: E1, E5a, E5b, AltBOC BeiDou: B1, B2 SBAS: L1 C/A WAAS/MSAS/EGNOS QZSS: L1 C/A, L1C ^c , L2C
Tracking	
Multipath Reduction	Yes, code and carrier
PLL/DLL Settings	Bandwidth, order, adjustable
SBAS	WAAS/EGNOS/MSAS
Quartz Lock Loop (QLL)	Protection against vibrations

Table 8. General Receiver Specifications

Data and Memory	
Memory	Removable SD/SDHC
Data Update/Output Rate	1 Hz – 50 Hz selectable (10 Hz standard for RTK operation)
Real Time Data Output	TPS, RTCM SC104 v 2.x, 3.x (including MSM); CM/CMR+
ASCII Output	NMEA 0183 version 2.x and 3.0
Communication	
Optional Radio Type	Integrated UHF/FH915
Base Radio Output	1.0 W, user selectable
Optional Cellular	Integrated HSPA/CDMA
I/O Communications	Class 2 <i>Bluetooth</i> [®] USB and Serial

Table 8. General Receiver Specifications

Output	
Communication Ports	<ul style="list-style-type: none"> • High-speed RS232 serial port (rimmed in black) • USB port up to 12 Mbps (rimmed in yellow) • Internal Bluetooth (port D)
Serial Port Specifications	<p>RS232 Serial Port:</p> <ul style="list-style-type: none"> • Baud rate: 460800, 230400, 115200 (default), 57600, 38400, 19200, 9600, 4800, 2400, 1200, 600, 300 • Flow control: RTS/CTS • Length: 7 or 8 (default) • Stop bit: 1 (default), 2 • Parity: None (default), Odd, Even
Connectors	<ul style="list-style-type: none"> • Modem Antenna (BNC or reverse polarity TNC depending on modem type) • PWR • RS232 Serial • USB
MINTER (LED Display)	<ul style="list-style-type: none"> • 6 external LEDs • ON/OFF control input (power button) • Data logging control (FUNCTION button)

Table 8. General Receiver Specifications

NMEA	
NMEA 0183 Output	Ver. 2.1, 2.2, 2.3, 3.0 output
Messages	GGA, GLL, GMP, GNS, GRS, GSA, GST, GSV, HDT, RMS, ROT, VTG, UID, and ZDA
Output Interval	1Hz standard; 10, 20, 50 Hz optional
DGPS	
Correction Format	RTCM SC104 Ver 2.1, 2.2, 2.3, 3.0, and 3.1
RTCM Message Type	1, 3, 9, 31, 32, 34; user selectable
Process Interval	1Hz standard; 10, 20, 50 Hz optional
Output Interval for RTCM Correction Data	1Hz standard
Elevation Mask	0 to 90 degrees (independent of data logging)
Real-Time Kinematic Mode	
Correction Format ^d	RTCM SC104 Ver 3.1, 3.0, 2.3, 2.2, or 2.1 CMR/CMR+ (Trimble compatible), TPS proprietary
Supported RTK Network Solutions	VRS, MAC, FKP

Table 8. General Receiver Specifications

Ambiguity Initialization	On-The-Fly (OTF): L1, L1/L2
Baseline Length	Up to 50km, depending on atmospheric and multipath conditions
Initialize Time	1 second to 10 min., depending on the baseline length (D) and multipath conditions
Output Interval for CMR/RTCM	1Hz standard
Elevation	0 to 90 degrees (independent of data logging)
Solution Mode	Delay (synchronization) mode: 5 to 10 msec Extrapolation (not synchronized) mode: 10 to 20 msec
Process Interval	1Hz standard; 10, 20, 50 Hz optional
Latency	Delay mode: 5 to 10 msec. Extrapolation mode: 10 to 20 msec.
Status	Fix, float, DOP, data link status, modem latency, common satellites
Results	RTK coordinates, HRMS, VRMS

Table 8. General Receiver Specifications

Survey Modes	
Base or Rover	Autonomous (standalone) DGPS (w/ user base) DGPS (w/ SBAS) Static Kinematic (continuous, stop and go) RTK (delay, extrapolation)
Accuracy (RMS)^e	
Static ^f	H: 3.0 mm + 0.1 ppm V: 3.5 mm + 0.4 ppm
RTK	H: 5 mm + 0.5 ppm V: 10 mm + 0.8 ppm
DGPS	User Base: H: 0.4m V: 0.6m SBAS: H: 1.0m V: 1.5m
Autonomous Accuracy	H: 1.5m RMS V: 2.0m RMS

Table 8. General Receiver Specifications

Cold Start	<60 sec.
Warm Start	<35 sec.
Hot Start	<10 sec.
Reacquisition	<1 sec.

- a. Patent pending. Multiple patents are associated with Fence Antenna™ technology.
- b. A positioning solution for L1C, GPS L5, and Galileo signals will be integrated and made available when the constellations mature, and are ready for commercial use.
- c. A positioning solution with these signals will be integrated and made available when the constellation matures and is ready for commercial use.
- d. CMR/CMR+ is a third-party proprietary format. Use of this format is not recommended and performance cannot be guaranteed. Use of industry standard RTCM 3.x is always recommended for optimal performance.
- e. Subject to multipath anomalies and atypical satellite geometry. GNSS survey best practices must always be applied.
- f. Under nominal observation conditions and strict processing methods, including use of dual frequency GPS, precise ephemerides, calm ionospheric conditions, approved antenna calibration, unobstructed visibility above 10 degrees and an observation duration of at least 3 hours (dependent on baseline length).

DUHF II Internal Modem Board Details (Optional)

Table 9. DUHF II Internal Modem Board Specifications

Operating Frequency Range	<ul style="list-style-type: none"> • 410MHz – 470MHz for Rover • 420MHz – 470MHz for Base
Channel Spacing	12.5 KHz / 20KHz / 25KHz user-selectable
Signal Modulation	<ul style="list-style-type: none"> • 4FSK • GFSK
Communication Mode	Time division duplex
Supported Protocol(s)	Proprietary, PDL, Trimble, Satel
Transmitter Carrier Power	10, 20, 50, 100, 200, 500 and 1000 mW, user selectable
Receiver Sensitivity	GFSK: -119 dBm at 10^{-4} BER and 12.5 KHz spacing 4FSK: -114 dBm at 10^{-4} BER and 12.5 KHz spacing
Receiver Dynamic Range	-119 to -1dBm
Serial Data Rate	1200, 2400, 4800, 9600, 14400, 19200, 38400, 57600, 115200 bps, user selectable
Radio Data Rate	25KHz: 9600 bps for GFSK and 19200 pbs for 4FSK 12.5KHz: 4800 bps for GFSK and 9600 pbs for 4FSK
Antenna Type	Whip antenna

Table 9. DUHF II Internal Modem Board Specifications

Antenna Connector	BNC
Error Correction	FEC on/off

FH915 Internal Modem Board Details

Table 10. FH915 Internal Modem Board Specifications

Frequency Range Country/Region/Purpose Dependent	<ul style="list-style-type: none"> • 902.2 MHz – 927.8 MHz (128 channels), USA • 915.2 MHz – 927.8 MHz (63 channels), AUS • 920.8 MHz – 927.8 MHz (36 channels), NZL
Signal Structuring	Frequency-hopping spread spectrum
Hopping Pattern	5 per band, user-selectable
Hopping Channels	128 Channels
Occupied Bandwidth	± 100KHz
Frequency Modulation Technique	FSK, 64 Kbps
Network Topology	Point-to-point, Point-to-multipoint
System Gain	135dB

Table 10. FH915 Internal Modem Board Specifications

Operation Mode	Transmitter, receiver, repeater
Protocol	FH915, FH915+
Transmitter Carrier Power	250mW (24 dBm)/1 W (30 dBm), user selectable
Receiver Sensitivity	-105 dBm at 10^{-4} BER
Receiver Dynamic Range	105 dB
Serial Interface	RS232
Serial Data Rate	9600, 19200, 38400, 57600 bps, user selectable
Effective Radio Link Rate	9600, 10200, 17000, 51000 bps, user selectable for FH915 3600, 4800, 6600, 19200 for FH915+
Error Correction	FEC (15.7), majority decoding
Antenna Type	1/2 wave articulating whip
Antenna Connector	Reverse polarity TNC
Antenna Gain	2.5 dBi

Optional Cell Module Details

Table 11. Cellular Specifications

Quad Band GSM/GPRS/EDGE Module ^a	
Supported Bands	GSM 850/900/1800/1900 MHz
TX Power	850/900 MHz – Class 4 (2 Watt) 1800/1900 MHz – Class 1 (1 Watt)
Data Features	GPRS, Multi-slot Class 10, <i>Max downlink 85.6 kbps, max uplink 42.8 Kbps</i> EDGE, Multi-slot Class 10, <i>Max BR downlink 236.5 Kbps</i> CSD, <i>Max BR 14.4 Kbps</i>
AT Command Set	GSM 07.05, 07.07 and 07.10
Regulatory and Approvals	FCC, IC COFETEL (Mexico) CMII (China) PTCRB R&TTE/CE GCF QS9000 manufacturing RoHS/WEEE/CCC

Table 11. Cellular Specifications (Continued)

Dual Band CDMA 1xRTT Module	
Supported Bands ¹	CDMA 800/1900 MHz
TX Power	800 MHz – Class 3 (24 dBm) 1900 MHz – Class 2 (24 dBm)
Data	1x/QNC/HSPD CSD, <i>Max BR 14.4 Kbps</i>
AT Command Set	N/A
Regulatory and Approvals	CDG1, CDG2 FCC, IC, CCC EMC QS9000 manufacturing RoHS/WEEE

¹Topcon GNSS receivers equipped with integrated C24 wireless modules are authorized to operate in the US only on the Verizon™ wireless network.

3.5G Wireless Module (Quad-band GSM and UMTS/HSPA)	
Supported Bands	GSM 850/900/1800/1900 MHz UMTS/HSPA 850/1900/2100 MHz

Table 11. Cellular Specifications (Continued)

TX Power	UMTS/HSPA - Class 3 (0.25 Watt) GSM 850/900 MHz – Class 4 (2 Watt) GSM 1800/1900 MHz – Class 1 (1 Watt) EDGE 850/900 MHz – Class E2 (0.5 Watt) EDGE 1800/1900 MHz – Class E2 (0.4 Watt)
Data Features	UMTS/HSDPA/HSUPA 3GPP, Release 6 GSM/GPRS 3GPP, Release 9 Max uplink 5.76 Mbps, max downlink 7.2 Mbps EDGE, Multi-Slot class 12 CSD, <i>Max BR 14.4 Kbps GSM, Max BR 14.4 Kbps UMTS</i>
AT Command Set	GSM 07.05, 07.07
Regulatory and Approvals	FCC, IC PTCRB R&TTE/CE GCF RoHS/WEEE ACMA BABT

a. The GR-5 receiver, featuring Vanguard technology, supports high speed HSPA cellular modules.

Bluetooth Module Details

Table 12. Bluetooth Module Specifications

Range	up to 10 m (indoor); up to 20 m (outdoor)
Type	Class 2
Service classes	Miscellaneous
Supported profiles	LM, L2CAP, SDP, SPP
Frequency Country Code	North America and Europe

Connector Specifications

The GR-5 has one antenna connector for radio transmission/reception and three port connectors for power and data upload/download.

Radio (Modem) RF Connector

The modem connector (Table 13) is a reverse TNC connector for 915+ radio and a BNC connector for UHF radio.

Table -13. Modem Connector Specifications

Modem	Type	Signal Type	Dir	Details
915+	Reverse TNC	Modem I/O	I/O	RF/GSM output from modem antenna
DUHFII	BNC	Modem I/O	I/O	RF/GSM output from modem antenna

Power Connector

Rimmed in red, the power connector (Figure 28) is a sealed receptacle, 5 pin, ODU part number G80F1C-T05QF00-0000.

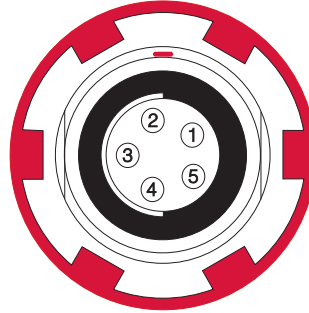

Figure 28. Power Connector

Table 14 describes power connector specifications.

Table 14. Power Connector Specifications

Number	Signal Name	Dir	Details
1	Power_INP	P	9 to 21 volts DC input
2	Power_INP	P	9 to 21 volts DC input
3	Power_GND	P	Ground, power return

Table 14. Power Connector Specifications (Continued)

Number	Signal Name	Dir	Details
4	Power_GND	P	Ground, power return
5	Aux_Power	P	9 to 21 volts DC input

Serial C-RS232 Connector

Rimmed in black, the serial RS232 connector (Figure 29) is a sealed receptacle, 7 pin, ODU part number G80F1C-T07QC00-0000.



Figure 29. Serial RS232 Connector

Table 15 gives the RS232 cable connector specifications.

Table 15. RS232 Connector Specifications

Number	Signal Name	Dir	Details
1			Not used
2	GND	-	Signal ground
3	CTS	I	Clear to send
4	RTS	O	Request to send
5	RXD	I	Receive data
6	TXD	O	Transmit data
7			Not used

USB Connector

Rimmed in yellow, the USB connector is a sealed receptacle, 4 pin TPS cable connector (Figure 30).

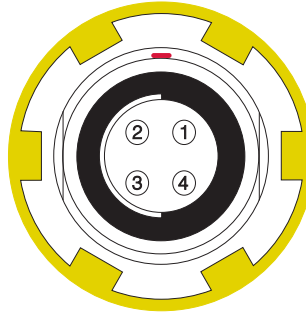

Figure 30. USB Connector for GGD Options

Table 16 gives the USB connector specifications.

Table 16. USB Specifications

Number	Signal Name	Dir	Details
1	USB_PWR	P	Bus power input
2	USB D-	I/O	Data minus
3	USB D+	I/O	Data plus
4	GND	P	Ground

Brazil-Only Radio Specifications

The equipment will be commercialized in Brazil only with the following technologies (O equipamento será comercializado no Brasil apenas com as seguintes tecnologias):

- Bluetooth V. 2.1 EDR
- Digital UHF II (459-460 MHz e 469-470 MHz) – Modulações GMSK e 4-Level FSK (4LFSK)

Table 17. Brazil-Only General Information

Parameter	Specification
Model (Modelo)	GR-5
Description (descrição)	GR-5 with DUHF (459-460, 469-470 MHz x12.5 KHz spacing) + BlueTooth
Type (Tipo)	Transmissor Digital - Categoria II

Table 18. Especificações Modem UHF Digital II para o Brasil

Parameter	Specification
Operating Frequency Range (Faixa de frequência de operação)	UHF 459-460, 469-470 MHz
Modulation Techniques (técnicas de modulação)	GMSK and 4-Level FSK (4LFSK)
Maximum Transmit Power (Máxima de Transmissão de Energia)	1 Watt
Protocols (Protocolos)	Satel 4LFSK PDL GMSK PDL 4LFSK TrimTalk GMSK
Occupied Bandwidth (channel spacing)	12.5 KHz
Data Transmission Rate at 12.5 kHz Channel Spacing (Taxa de transmissão de dados de 12.5 KHz canal espaçamento)	4800, 9600 bps
Data Speed of Serial Interface (A velocidade de dados de interface serial)	Max 115200 bps
Forward Error Correction	Yes (Sim)
Scrambling	Yes (Sim)

Table 18. Especificações Modem UHF Digital II para o Brasil (Continued)

Parameter	Specification
Communication Mode (modo de comunicação)	Half-Duplex (Meio Duplex)
Operation Modes: (modos de operação)	Transmitter (Transmissor) Receiver (Recebedor) Repeater (Repetidor)

Table 19. Módulo Bluetooth Especificações

Parameter	Specification
Range (Alcance)	Up to 10 m (indoor), up to 20 m (outdoor) [Até 10 m (interior), até 20 m (ao ar livre)]
Type (Atração)	Class 2
Service Class (Classe de Serviço)	Miscellaneous (variado)
Support Profiles (Perfis de apoio)	LM, L2CAP, SDP, SPP
Frequency Country Code (Frequência Código do país)	North America and Europe (América do Norte e Europa)

Product Identification



Earlier versions of the GR-5 receiver supported 216 Universal Tracking channels. The new GR-5 receiver, featuring Vanguard™ Technology, supports 226 channels, which are listed in Table 20 by serial number range.

Table 20. Product Serial Numbers

Cellular Modem	Serial Number
GR-5 (With Digital UHF II)	
No cellular modem	1117-2xxxx
HSPA modem	1118-2xxxx
CDMA modem	851-2xxxx
GR-5 (With FH915+)	
No cellular modem	800-2xxxx
HSPA modem	1203-2xxxx

You can also identify the new GR-5 receiver, featuring Vanguard Technology, by the serial number label on the receiver, which contains the Topcon Vanguard Technology logo.

SD/SDHC Card Recommendations

This section provides a recommended list of SD/SDHC cards that were tested with the receiver. This list of recommendations is based on testing results available to date and should not be considered a comprehensive list. The receiver is capable of working with SD/SDHC cards with a storage capacity of up to 32GB.



For optimal and consistent performance, Topcon recommends using the SD/SDHC cards listed in this section.

Topcon recommends using the following list of SD/SDHC cards with your receiver:

- Swissbit® Industrial 2GB
- SanDisk® Ultra II
- Transcends® Ultra Industrial 2 GB
- APRO® Industrial 4 GB

Safety Warnings

General Warnings



Topcon receivers are designed for survey/construction and related uses (that is, surveying coordinates, distances, angles and depths, and recording such measurements). This product should never be used:

- Without the user thoroughly understanding this manual.
 - After disabling safety systems or altering the product.
 - With unauthorized accessories.
 - Without proper safeguards at the job site.
 - Contrary to applicable laws, rules, and regulations.
-

Battery Warnings



Never attempt to open the casing of the detachable batteries! Lithium-Ion batteries can be dangerous if mishandled!



Do not incinerate or heat the battery above 212 degrees fahrenheit (100 degrees celsius). Excessive heat can cause serious damage and possible explosion.



Tampering with the batteries by end users or non-factory authorized technicians will void the battery's warranty.

- Do not disassemble the batteries.
 - Do not charge in conditions different than specified.
 - Do not use other than the specified battery charger.
 - Do not short circuit.
 - Do not crush or modify.
-

Receiver Warnings



Tampering with the receiver by the end users or non-factory authorized technicians will void the receiver's warranty:

- Do not attempt to open the receiver and modify any of its internal components.
 - Do not charge in conditions different than specified.
 - Do not short circuit.
-

Usage Warnings



If this product has been dropped, altered, transported or shipped without proper packaging, or otherwise treated without care, erroneous measurements may occur.

The owner should periodically test this product to ensure it provides accurate measurements. Inform TPS immediately if this product does not function properly.



Only allow authorized Topcon warranty service centers to service or repair this product.

The following sections provide information on this product's compliance with government regulations for use.

FCC Compliance

This equipment complies with FCC radiation exposure limits set forth for uncontrolled equipment and meets the FCC radio frequency (RF) Exposure Guidelines in Supplement C to OET65. This equipment has very low levels of RF energy that it deemed to comply without maximum permissive exposure evaluation (MPE). But it is desirable that it should be installed and operated with at least 30cm and more between the radiator and person's body (excluding extremities: hands, wrists, feet and ankles).

This equipment has been tested and found to comply with the limits for a Class A digital device pursuant to part 15 of the FCC rules. These limits are designed to provide reasonable protection against harmful interference when the equipment is operated in a commercial environment. This equipment generates, uses, and can radiate radio frequency energy and, if not installed and used in accordance with the instruction manual, may cause harmful interference to radio communications. Operation of this equipment in a residential area is likely to cause harmful interference in which case the user will be required to correct the interference at his own expense.

If this equipment does cause interference to radio or television equipment reception, which can be determined by turning the equipment off and on, the user is encouraged to try to correct the interference by one or more of the following measures:

- Reorient or relocate the receiving antenna.
- Move the equipment away from the receiver.
- Plug the equipment into an outlet on a circuit different from that to which the receiver is powered.
- Consult the dealer or an experienced radio/television technician for additional suggestions.



Any changes or modifications to the equipment not expressly approved by the party responsible for compliance could void your authority to operate such equipment.

Industry Canada Compliance

This equipment complies with IC radiation exposure limits set forth for uncontrolled equipment and meets RSS-102 of the IC radio frequency (RF) exposure rules. This equipment has very low levels of RF energy that it deemed to comply without maximum permissive exposure elevation (MPE). But it is desirable that it should be installed and operated with at least 30 cm or more between the radiator and person's body (excluding extremities: hands, wrists, feet, and ankles).

This class A digital apparatus complies with Canadian ICES-003.

Cet appareil numérique de la classe A est conforme à la norme NMB-003 du Canada.

This device complies with Industry Canada license-exempt RSS standard(s). Operation is subject to the following two conditions: (1) this device may not cause interference, and (2) this device must accept any interference, including interference that may cause undesired operation of the device.

Le présent appareil est conforme aux CNR d'Industrie Canada applicables aux appareils radio exempts de licence. L'exploitation est autorisée aux deux conditions suivantes : (1) l'appareil ne doit pas produire de brouillage, et (2) l'utilisateur de l'appareil doit accepter tout brouillage radioélectrique subi, même si le brouillage est susceptible d'en compromettre le fonctionnement.

IC RF Radiation Exposure Statement

When installing, locate or point this device away from the installer, so it does not emit RF field in excess of Health Canada's limits for the general population. Consult Safety Code 6 from Health Canada's website at www.hc-sc.gc.ca/rpb.

IC Additional Statement with Detachable Antennas

This device (with UHF II modem) has been designated to operate with the antennas listed below and have a maximum gain of 2.4dBi. Antennas not included in this or having a gain greater than 2.4dBi are strictly prohibited for use with this device. The required antenna impedance is 50 ohms.

GR-5 UHF II 2.4dBi whip antenna

Manufacture/Type

420-450 MHz LAIRD or ANTENEX/G420BN

450-470 MHz LAIRD or ANTENEX/G450BN

The device (with FH915 modem) has been designated to operate with the antennas listed below and have a maximum gain of 2.1dBi. Antennas not included in this or having a gain greater than 2.1dBi are strictly prohibited for use with this device. The required antenna impedance is 50 ohms.

GR-5 FH915 2.5dBi Sleeve Dipole Antenna

Manufacture/Type

890-960 MHz LARSEN SPDA17RP918

Connect Type: TNC male reverse polarity

902-928 MHz

NEARSON S467xx-915S

Connector Type: TNC male reverse polarity

Community of Europe Compliance

The product described in this manual is in compliance with the R&TTE and EMC directives from the European Community.

European Community Declaration of Conformity with R&TTE Directive 1999/5/EC

The following standards were applied: (R&TTE Directive 1999/5/EEC)

- ETSI EN 300 113-2 v1.5.1(2011-11)
- ETSI EN 301 489-1 v1.9.2(2011-09)
- ETSI EN 301 489-7 v1.3.1(2005-11)
- ETSI EN 300 440-2 v1.4.1(2010-08)
- ETSI EN 300 328 v1.7.1(2006-10)
- ETSI EN 301 489-3 v1.4.1(2002-08)
- ETSI EN 301 908-1 v5.2.1(2011-05)
- ETSI EN 301 489-5 v1.4.1(2002-08)
- ETSI EN 301 489-17 v1.5.1(2010-10)
- ETSI EN 301 511 v9.0.2(2003-03)
- EN 60950-1:2006:+A11:2009 & A1:2010
- EN 55022:2010
- ETSI EN 301 489-24 v1.5.1(2010-10)
- ETSI EN 301 908-2 v5.2.1(2011-07)

This equipment is intended to be marketed in the following countries:

List of National Codes:

- AT DE MT GB
- BE GR NL IS
- CY HU PL LI
- CZ IE PT NO
- DK IT SK CH
- EE LV SI BG
- FILT ES RO
- FR LU SE TR

The equipment is labeled with a CE! mark that informs users the DIG UHFII frequency range 410-470 MHz is not harmonized throughout Europe and the specific country spectrum authority should be notified before a radio modem is used.



Use of this equipment requires a license.



L'impiego di questo impianto necessita una concessione.



Das Betreiben dieser Anlage unterliegt der Konzessionspflicht.



L'utilisation de cette installation nécessite une concession.

Declaration of Conformity (R&TTE Directive 1999/5/EC)

esky [Czech]	(<i>Topcon</i>) tímto prohlašuje, že tento (<i>GR-5</i>) je ve shod se základními požadavky a dalšími příslušnými ustanoveními směrnice 1999/5/ES.
Dansk [Danish]	Undertegnede (<i>Topcon</i>) erklærer herved, at følgende udstyr (<i>GR-5</i>) overholder de væsentlige krav og øvrige relevante krav i direktiv 1999/5/EF.
Deutsch [German]	Hiermit erklärt (<i>Topcon</i>) dass sich das Gerät (<i>GR-5</i>) in Übereinstimmung mit den grundlegenden Anforderungen und den übrigen einschlägigen Bestimmungen der Richtlinie 1999/5/EG befindet.
Eesti [Estonian]	Käesolevaga kinnitab (<i>Topcon</i>) seadme (<i>GR-5</i>) vastavust direktiivi 1999/5/EÜ põhinõuetele ja nimetatud direktiivist tulenevatele teistele asjakohastele sätetele.
English	Hereby, (<i>Topcon</i>) declares that this (<i>GR-5</i>) is in compliance with the essential requirements and other relevant provisions of Directive 1999/5/EC.
Español [Spanish]	Por medio de la presente (<i>Topcon</i>) declara que el (<i>GR-5</i>) cumple con los requisitos esenciales y cualesquiera otras disposiciones aplicables o exigibles de la Directiva 1999/5/CE.

[Greek]	ΜΕ ΤΗΝ ΠΑΡΟΥΣΑ (<i>Topcon Positioning Systems, Inc.</i>) ΔΗΛΩΝΕΙ ΟΤΙ (GR-5) ΣΥΜΜΟΡΦΩΝΕΤΑΙ ΠΡΟΣ ΤΙΣ ΟΥΣΙΩΔΕΙΣ ΑΠΑΙΤΗΣΕΙΣ ΚΑΙ ΤΙΣ ΛΟΙΠΕΣ ΣΧΕΤΙΚΕΣ ΔΙΑΤΑΞΕΙΣ ΤΗΣ ΟΔΗΓΙΑΣ 1999/5/ΕΚ.
Français [French]	Par la présente (<i>Topcon</i>) déclare que l'appareil (<i>GR-5</i>) est conforme aux exigences essentielles et aux autres dispositions pertinentes de la directive 1999/5/CE.
Italiano [Italian]	Con la presente (<i>Topcon</i>) dichiara che questo (<i>GR-5</i>) è conforme ai requisiti essenziali ed alle altre disposizioni pertinenti stabilite dalla direttiva 1999/5/CE.
Latviski [Latvian]	Ar šo (<i>Topcon</i>) deklar, ka (<i>GR-5</i>) atbilst Direktvas 1999/5/EK btiskajm prasbm un citiem ar to saisttajiem noteikumiem.
Lietuvi [Lithuanian]	Šiuo (<i>Topcon</i>) deklaruoja, kad šis (<i>GR-5</i>) atitinka esminius reikalavimus ir kitas 1999/5/EB Direktyvos nuostatas.
Nederlands [Dutch]	Hierbij verklaart (<i>Topcon</i>) dat het toestel (<i>GR-5</i>) in overeenstemming is met de essentiële eisen en de andere relevante bepalingen van richtlijn 1999/5/EG.
Malti [Maltese]	Hawnhekk, (<i>Topcon</i>), jiddikjara li dan (<i>GR-5</i>) jikkonforma mal-tijiet essenzjali u ma provvedimenti orajn relevanti li hemm fid-Direttiva 1999/5/EC.

Magyar [Hungarian]	Alulírott, (<i>Topcon</i>) nyilatkozom, hogy a (<i>GR-5</i>) megfelel a vonatkozó alapvető követelményeknek és az 1999/5/EC irányelv egyéb előírásainak.
Polski [Polish]	Niniejszym, (<i>Topcon</i>), deklaruje, że (<i>GR-5</i>) spełnia wymagania zasadnicze oraz stosowne postanowienia zawarte w Dyrektywie 1999/5/EC.
Português [Portugues]	(<i>Topcon</i>) declara que este (<i>GR-5</i>) está conforme com os requisitos essenciais e outras disposições da Directiva 1999/5/CE.
Slovensko [Slovenian]	(<i>Topcon</i>) izjavlja, da je ta (<i>GR-5</i>) v skladu z bistvenimi zahtevami in ostalimi relevantnimi določili direktive 1999/5/ES.
Slovensky [Slovak]	(<i>Topcon</i>) týmto vyhlasuje, že (<i>GR-5</i>) spa základné požiadavky a všetky príslušné ustanovenia Smernice 1999/5/ES.
Suomi [Finnish]	(<i>Topcon</i>) vakuuttaa täten että (<i>GR-5</i>) tyyppinen laite on direktiivin 1999/5/EY oleellisten vaatimusten ja sitä koskevien direktiivin muiden ehtojen mukainen.
Svenska [Swedish]	Härmed intygar (<i>Topcon</i>) att denna (<i>GR-5</i>) står i överensstämmelse med de väsentliga egenskapskrav och övriga relevanta bestämmelser som framgår av direktiv 1999/5/EG.

Brazil Anatel Compliance

Este equipamento opera em carater secundario isto e, nao tem direito a protecao contra interferencia prejudicial, mesmo do estacoes do mesmo tipo, enao pode causar interferencia a sistemas operando em carater primario.

- EAN Code: 0719-16-6473
- Homologation: (01) 0 789894509888

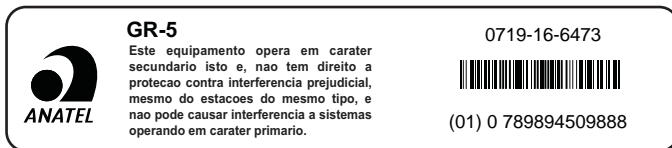

WEEE Directive

The following information is for EU-member states only:

The use of the symbol below indicates that this product may not be treated as household waste. By ensuring this product is disposed of correctly, to help prevent potential negative consequences for the environment and human health, which could otherwise be caused by inappropriate waste handling of this product. For more detailed information about the take-back and recycling of this product, please contact a supplier where you purchased the product or consult.



Bluetooth Transmission Statements/Compliance

This Bluetooth device is compliant to the following profiles of the core spec version 2.1/2.1+EDR:

- Baseband
- HCI
- Link Manager
- Radio

The radio has been tested using the maximum antenna gain of 2.3 dBi and the Bluetooth qualification is valid for any antenna with the same or less gain.

Warranty

Topcon laser and electronic positioning equipment are guaranteed against defective material and workmanship under normal use and application consistent with this Manual. The equipment is guaranteed for the period indicated, on the warranty card accompanying the product, starting from the date that the product is sold to the original purchaser by Topcon's Authorized Dealers.¹

During the warranty period, Topcon will, at its option, repair or replace this product at no additional charge. Repair parts and replacement products will be furnished on an exchange basis and will be either reconditioned or new. This limited warranty does not include service to repair damage to the product resulting from an accident, disaster, misuses, abuse or modification of the product.

Warranty service may be obtained from an authorized Topcon warranty service dealer. If this product is delivered by mail, purchaser agrees to insure the product or assume the risk of loss or damage in transit, to prepay shipping charges to the warranty service location and to use the original shipping container or equivalent. A letter should accompany the package furnishing a description of the problem and/or defect.

The purchaser's sole remedy shall be replacement as provided above. In no event shall Topcon be liable for any damages or other claim including any claim for lost profits, lost savings or other incidental or consequential damages arising out of the use of, or inability to use, the product.

1. The warranty against defects in a Topcon battery, charger, or cable is 90 days.

Glossary

B

Base Station – A GNSS receiver set up over a known point, which is used to derive correction information for nearby Rover (mobile) GNSS receivers.

BeiDou– BeiDou Navigation Satellite System maintained and operated by China.

Bluetooth® – Often used in place of cables, Bluetooth is open wireless technology for exchanging data over short distances from fixed and mobile devices.

G

GALILEO – The satellite system currently being maintained and operated by the European Union (EU) and European Space Agency (ESA).

GGD – GPS + GLONASS Dual Frequency signal tracking.

GLONASS – The Global Navigation Satellite System maintained and operated by the Russian Federation.

GNSS – Global Navigation Satellite Systems, such as GPS and GLONASS.

GPS – The Global Positioning System maintained and operated by the United States Department of Defense.

L

L1 and L2– For the ranging codes and navigation message to travel from the satellite to the receiver, they must be modulated onto a carrier frequency. In the case of the GPS design, two frequencies are utilized: one at 1575.42 MHz (10.23 MHz x 154) called L1 and the other at 1227.60 MHz (10.23 MHz x 120), called L2.

Light-Emitting Diode (LED) – Used as indicator lights on the receiver to display the status of the receiver’s components and control receiver operations.

M

MAGNET Field™ – Data controller software that is part of the MAGNET software system.

MAGNET Office™ – Post-processing and CAD solution software for surveying and grade application. It is part of the MAGNET software system.

MINTER – The receiver’s Minimum INTERface used to display and control data input and output.

N

Network RTK – Collects satellite observations from the reference stations within the network and sends RTK corrections to the Rover.

O

Option Authorization File (OAF) – This enables specific features for scalable performance of Topcon GNSS receivers.

P

Phase Center of Antenna – The point from which the electromagnetic radiation spreads spherically outward, with the phase of the signal being equal at any point on the sphere.

Pocket-3D – Field data collection software by Topcon for construction markets.

R

Real-Time Kinematic (RTK) – A precise method of real-time surveying. RTK enables you to check the measurement quality without having to process the data.

Root Mean Square (RMS) – Statistical measure of the magnitude of a varying quantity.

Rover – A mobile GNSS receiver and data collector used for determining location in the field.

S

Satellite-Based Augmentation Systems (SBAS) – Complements existing global navigation systems. SBAS transmits differential corrections and messages for navigation satellites that are within sight of a network or reference stations in a wide area, such as a continent.

Static Survey – Location determination when the receiver's antenna is stationary. This method provides the highest accuracy and requires the longest observation times.

T

Topcon Receiver Utility (TRU) – Receiver configuration software for receivers and peripheral devices. TRU is included on the GPS+ Software CD that accompanied your receiver.

U

Universal Serial Bus (USB) – A connection standard used by devices, such as a receiver, controller, computer, etc.



Topcon Positioning Systems, Inc.
7400 National Drive, Livermore, CA 94550
800-443-4567 www.topconpositioning.com



GR-5 Operator's Manual

P/N 7010-1004 Rev D 3/16

©2016 Topcon Positioning Systems, Inc.
All rights reserved. No unauthorized duplication.